

ZDUE-GSM-PLUS-V

User Manual



Dr. Neuhaus

Copyright Statement

The contents of this publication are protected by copyright. Translations, reprints, reproduction and storage in data processing systems require the express permission of Dr. Neuhaus Telekommunikation GmbH.

© 2011 by Dr. Neuhaus Telekommunikation GmbH

All rights reserved

Dr. Neuhaus Telekommunikation GmbH

Papenreye 65, D-22453 Hamburg

Telephone: +49 (40) 55304-0

Fax: +49 (40) 55304-180

Internet: <http://www.neuhaus.de>

Subject to technical alterations.

All trademarks and product designations are trademarks, registered trademarks or product designations of their respective owners.

Dr. Neuhaus Telekommunikation GmbH provides all goods and services on the basis of the General Terms and Conditions of Dr. Neuhaus Telekommunikation GmbH currently valid. All information is based on information provided by the manufacturer(s). No responsibility or liability will be assumed for incorrect or missing entries. The contents of this manual and the technical specifications may be changed without prior notice. The descriptions of the specifications in this manual do not constitute an agreement.

Product no. DNT8191

Doc. no. 8191AD012, version 1.1

Firmware-Version 4.017 or higher (ZDUE-GSM-PLUS-V)

Classification of the Safety Precautions

This manual contains safety precautions that must be observed to protect your own personal safety and to prevent any damage to this or other equipment. The notes on your personal safety are marked with a warning triangle; notes referring to equipment or property damage only are not marked with a warning triangle. Depending on the seriousness of the hazard, the precautions are illustrated in the following order.



Danger

means that death or serious injury **will** result if the corresponding precautions are not taken.



Warning

means that death or serious bodily injury **could** result if the corresponding precautions are not taken.



Be Careful

with a warning triangle means that minor bodily injury could result if the corresponding precautions are not taken.

Be Careful

without a warning triangle means that equipment damage could result if the corresponding precautions are not taken.

Attention

means that an undesired result or situation could result if the information in the note is not observed.

If more than one safety hazard is involved, the warning note with the highest hazard level will be indicated. If a warning referring to personal safety is indicated with the warning triangle, the same warning could also contain additional information on equipment damage.

General Information

The ZDUE-GSM-PLUS-V is compliant with the European EN60950:2006 standard, Information Technology Equipment - Safety Standards.

The ZDUE-GSM-PLUS-V is not designed to be connected to IT systems for the electrical power supply.

Please read through these installation instructions carefully before using the device.

Qualified Personnel

The respective device/system is only to be set up and operated in combination with this documentation. A device/system is only to be put into operation and operated by **qualified personnel**. Qualified personnel in the sense of the safety precautions in this documentation are persons who are authorized to put into operation, ground and mark devices, systems and electric circuits and systems according to the standards of safety engineering.

Intended Use

Please note the following:



Warning

The device is to be used only for the intended uses indicated in the spec sheets and in this document. The correct, safe operation of the product assumes proper transport, proper storage, set-up and assembly as well as careful operation and servicing.

Disconnection from the Power Supply Circuit



Warning

An easily accessible, all-pole circuit breaker in the power supply circuit is required for the house installation. Alternatively, a single-pole circuit breaker can be used in the outer conductor as long as a distinct neutral conductor has been integrated into the supply line. In Germany, the circuit breaker must at least meet the requirements of the DIN VDE series 0100 standard.

Installation Fuse



Warning

The house installation requires an installation fuse that complies with the DIN VDE series 0100 standard and is properly adapted to the cable cross-section of the power supply line. The additional short-circuit protection must have a selectivity of $I > 1500A$.

Transient Overvoltages



Warning

The ZDUE-GSM-PLUS-V are devices in Overvoltage Category III. If the ZDUE-GSM-PLUS-V are likely to be exposed to higher transient overvoltages than those in Overvoltage Category III when connected, it will be necessary to take further safety precautions for the installation.

Wireless Equipment



Warning

Never use the device in areas in which the use of wireless equipment is prohibited. The device contains a radio transmitter, which could interfere with the operation of such medical electronic equipment as hearing aids or pacemakers. A doctor or the manufacturer of such devices can provide more detailed information.

To avoid demagnetizing data media, do not store any diskettes, credit cards or other magnetic data media close to the device.

Antenna Installation



Warning

The recommended radiation limits of the German Commission on Radiological Protection (www.ssk.de) from 13/14 September 2001 must be observed.

Attention

When laying the antenna cable, be sure to adhere to the bend radiuses. If you do not adhere to the bend radiuses of the antenna cable, this will result in a deterioration in the quality of the transmission and reception attributes of the device. The minimum bend radius must not be less than 5 times the cable diameter statically and 15 times the cable diameter dynamically.

Installation of an Outside Antenna



Be Careful

When installing an antenna outdoors, it is absolutely necessary that the antenna is installed properly by qualified technicians.

The outdoor antenna must be grounded to protect it against lightning strikes. The outdoor antenna shield must be reliably connected with the protective ground.

The corresponding national installation guidelines must be followed for the installation process.

In Germany, this is the VDE 0185 (DIN EN 62305) Parts 1 to 4 series of standards for buildings equipped with lightning protection systems and the VDE 0855 (DIN EN 60728-11) series of standards if there is no lightning protection system installed.

Connection Costs for GPRS

Be Careful

Please note that when a connection is only being (re-)set up, data packets incurring costs are exchanged during connection attempts to the other party (e.g. server switched off, wrong destination address, etc.) as well as to maintain the connection.

Contents

1	Functions.....	9
1.1	Intended purpose.....	9
1.2	Topology.....	9
1.3	Connect meters.....	10
1.4	Functionality.....	10
1.5	The interfaces of the ZDUE-GSM-PLUS-V.....	11
1.6	Access protection.....	11
1.7	Timer and module reset.....	12
1.8	Configuration (parameterisation) and firmware update.....	12
2	Operating elements, Connections and function indicators.....	13
2.1	Internal components of the device.....	13
2.2	Service button.....	13
2.3	DIP Switch.....	13
2.4	LEDs.....	14
2.5	Connections on the terminal block, RJ45 jack.....	15
3	Setup.....	16
3.1	Inserting the SIM card.....	16
3.2	Connecting the meters.....	17
3.3	Connecting the ZDUE-GSM-PLUS-V to the power supply.....	17
3.4	Fitting and connecting the antenna.....	18
3.5	Configuring the device if necessary.....	19
3.6	Parameterising the SIM PIN.....	19
4	Interfaces.....	20
4.1	The GSM interface.....	20
4.2	Meter interfaces.....	20
4.3	Interface types.....	21
4.4	Auxiliary power source.....	22
5	Operation.....	24
5.1	AT Mode.....	24
5.2	Meter Mode.....	25
5.3	Controlling according to EN62056-1.....	25
6	Configuration.....	27
6.1	Configuration by software.....	27
6.2	Parameters.....	28
6.3	Parameter classes.....	29
6.3.1	Parameter class 54.....	29
6.3.2	Parameter class 79.....	29
6.4	Register data set of the ZDUE-GSM-PLUS-V.....	32
6.4.1	General.....	32
6.4.2	Format of the error status.....	33
6.5	Communication commands according to DIN EN 62056-21.....	33
6.5.1	Error messages.....	34
6.5.2	Set password.....	34
6.5.3	Parameterisation commands.....	35
6.5.4	Parameter transfer command.....	36
6.5.5	Time/date commands.....	37
6.5.6	Status commands.....	38
6.5.7	Service commands.....	39
7	GPRS Mode.....	43
7.1	Configuration.....	43
7.2	Behaviour for the GPRS dial-in.....	44
7.3	GPRS Access Parameter (Parameter classes 60 and 61).....	45
7.4	GPRS-/IP-Server mode.....	47
7.4.1	Access protection.....	49
7.4.2	Function indicators.....	50
7.4.3	Parameters.....	50

7.4.4 Register data set in GPRS mode	54
7.4.5 Communication commands according to DIN EN 62056-21	54
8 Technical data	56

1 Functions

1.1 Intended purpose

The ZDUE-GSM-PLUS-V is a meter data transmission device. It is used for remote reading and remote monitoring of electricity meters as well as meters for other media.

Data transmission for remote reading and remote monitoring can take place via:

- one of the common GSM networks using the Circuit Switched Data service (CSD)
- one of the common GSM networks using the General Packet Radio Service (GPRS)

In the following, the ZDUE-GSM-PLUS-V in CSD mode will be described first. Different or supplementary functions in GPRS mode are described in chapter 7.

1.2 Topology

With the ZDUE-GSM-PLUS-V, data transmission for remote reading and remote monitoring can take place via one of the common GSM networks.

The ZDUE-GSM-PLUS-V supports the following GSM services

... CSD – Circuit Switched Data (Dial-up data connection)

CSD operation

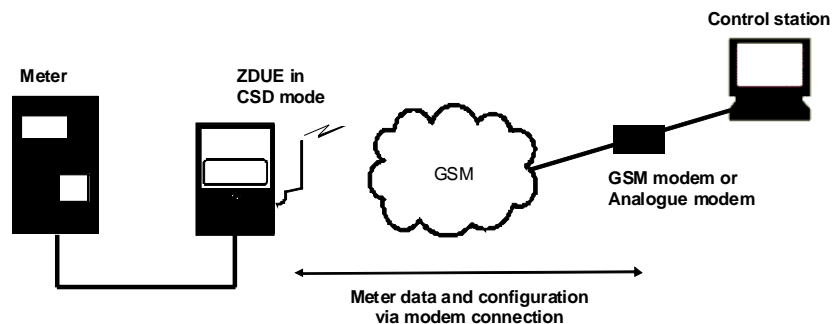

... GPRS – General Packet Radio Service (Paket-oriented data service)

GPRS-/IP-Server mode

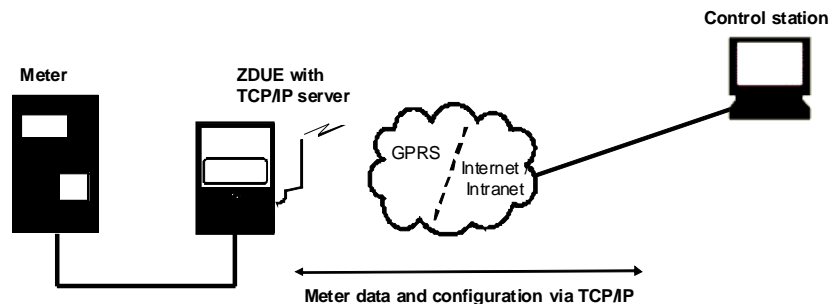

1.3 Connect meters

The ZDUE-GSM-PLUS-V has the following interfaces for the connection of meters: CL1, RS232 and RS485. The maximum permissible number of meters can be connected to each of these interfaces simultaneously.

In addition, the device also has an auxiliary power source (9V) to supply the meters.

For remote reading of the meters by the control centre, the ZDUE-GSM-PLUS-V can connect all of the connected meters to the control centre in sequence during a single connection. The control centre communicates therefore with the connected meters directly. The ZDUE-GSM-PLUS-V just transfers the data in both directions without modification. It only adapts bitrate or data format, if the mode C function is enabled.

1.4 Functionality

The integrated modem of the ZDUE-GSM-PLUS-V receives from the GSM network data calls that have been initiated by the control centre.

The control centre can call

- from the GSM network via a GSM modem (up to 9600 bps)
- from the fixed network via an analogue modem (up to V.32; 9600 bps)
- from the fixed network via an ISDN end device (V.110).

The ZDUE-GSM-PLUS-V that is called responds to the telegrams transmitted by the control centre as follows:

- It connects to the meters which are connected to its interfaces (CL1, RS-232, RS-485).
- It receives parameterisation commands and carries them out.

The GPRS mode is described in

chapter 7 - GPRS Mode

7.4 - GPRS-/IP-Server mode

1.5 The interfaces of the ZDUE-GSM-PLUS-V

The ZDUE-GSM-PLUS-V has various interfaces for connecting meters:

- CL1
- RS-485
- RS-232

Meters can be connected to all interfaces simultaneously.

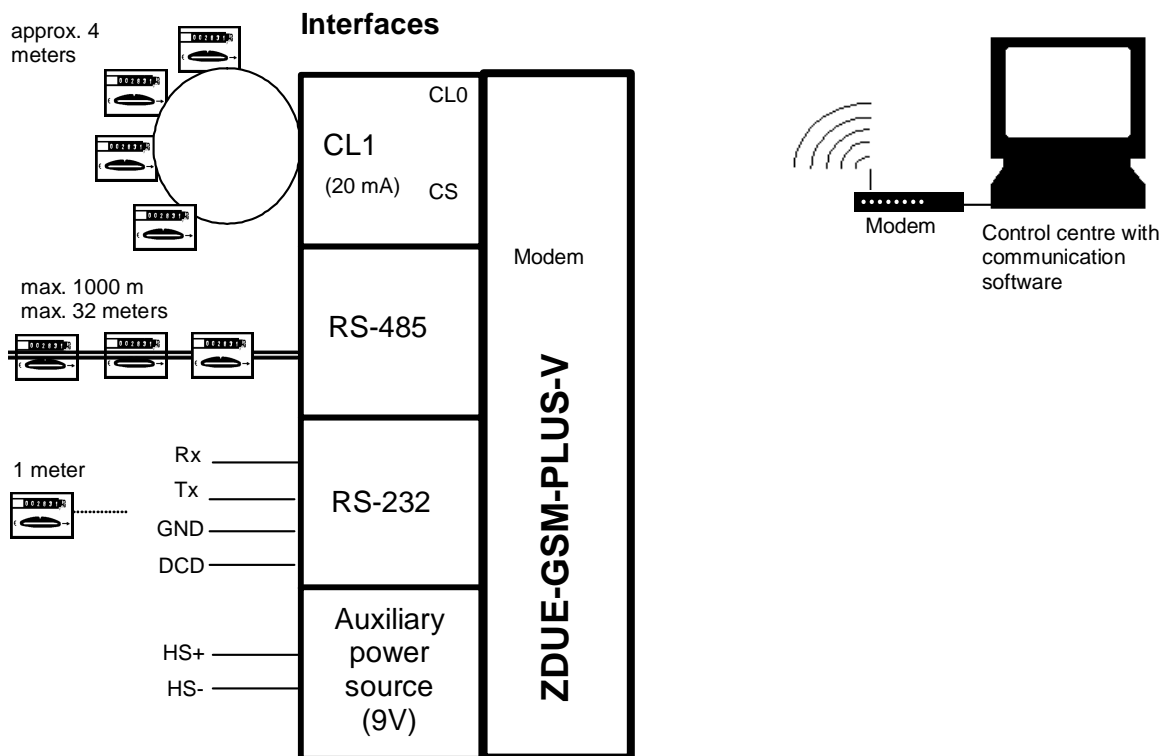

1.6 Access protection

... via password

For protection against unauthorised access, password entry can be configured. In this case the ZDUE-GSM-PLUS-V queries the caller for the agreed password; the caller must then transmit it during the configured time period (password timeout). If the password is incorrect or the timeout is exceeded, the ZDUE-GSM-PLUS-V terminates the connection. The password is parameterisable.

1.7 Timer and module reset

Although the ZDUE-GSM-PLUS-V does not have a real-time clock, a timer is operated on the basis of and with the accuracy of the processor crystal.

This timer controls the automatic module reset function that can be activated and configured in parameter class 79.

The automatic reset cycle starts when the device is switched on, i.e. the first module reset takes place after the parameterised period elapses after the device is started. Additional module resets then follow at the time intervals determined by the parameterised period.

The time for the daily watchdog (which is likewise configured in parameter class 79) is not used by the ZDUE-GSM-PLUS-V.

1.8 Configuration (parameterisation) and firmware update

Configuration by software

Configuration is performed using configuration software, e.g. Dr. Neuhaus ZDUEset. Parameterisation commands are transmitted to the ZDUE-GSM-PLUS-V with the aid of this software.

The parameterisation commands can be transmitted to the ZDUE-GSM-PLUS-V via the GSM network (remote configuration) or directly via the RS-232 interface (local configuration).

Configuration by DIP switch

Using the DIP switch inside the ZDUE-GSM-PLUS-IV the operation mode of the ZDUE-GSM-PLUS-V can be switched between Meter-Mode and AT-Mode. Refer to chapter 5.1 and 5.2.

Firmware update

A firmware update can be performed via the configuration software (e.g. Dr. Neuhaus ZDUEset) from a computer that is connected locally directly to the RS-232 interface of the ZDUE-GSM-PLUS-V.

2 Operating elements, Connections and function indicators

2.1 Internal components of the device

To insert the SIM card and to change the device settings via DIP switch, the device must be opened. The following diagram provides an overview of the internal components of the device that are important for the user:

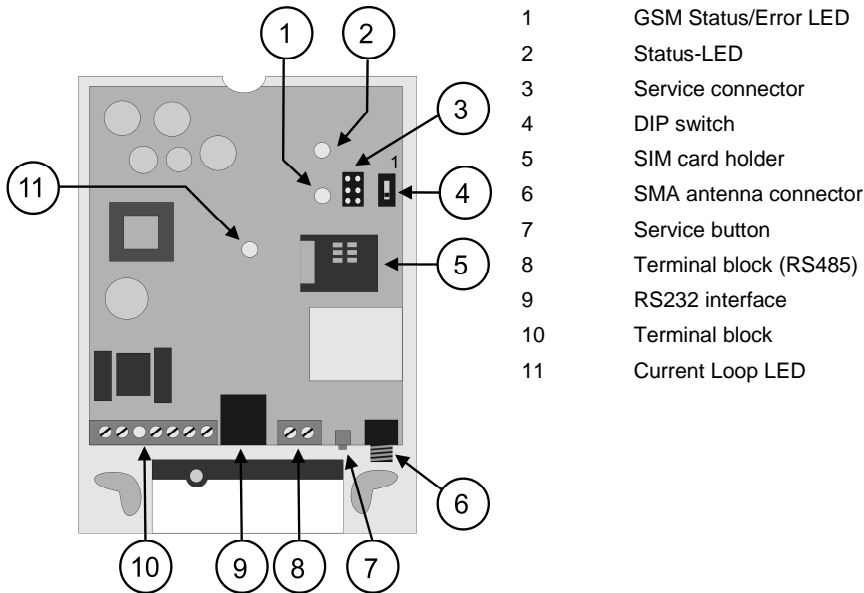

2.2 Service button

The service button (see 2.1, (7)) can be used both to reset all device parameters to the factory setting, and as a simple way to read their firmware version. The service button is only effective in meter mode.

Resetting to factory setting

Pressing the service button once and holding it for more than five seconds **in ongoing operation** deletes the parameterisation set in the device via EN62056-21 commands. When the button is released the ZDUE-GSM-PLUS-V is restarted, and when it boots it adopts the settings according to firmware defaults.

Outputting the firmware version during booting

If the service button is held down **during switch-on**, the ZDUE-GSM-PLUS-V outputs the current firmware version of the device via the serial interface.

The data format of the connected terminal software has to be set to 19200 Baud 8N1.

2.3 DIP Switch

The DIP switch allows toggling between Meter Mode and AT-Mode. Refer to chapter 5.

2.4 LEDs

The device is equipped with 3 LEDs for checking the operating status. They service to indicate the functions being executed at the moment and the respective status.

LED	Colour / Action	Meaning
Power	<ul style="list-style-type: none"> • Green & Yellow with light pipe Continuously green Continuously yellow 	Operating voltage present
		GSM module on
Status/Error	<ul style="list-style-type: none"> • Orange 3s on / 3 x flashing briefly 3s on / 2 x flashing briefly 3s on / 1 x flashing briefly 3s off / 1x flashing briefly 3s off / 2x flashing briefly 3s off / 3x flashing briefly 3s off / 4x flashing briefly Continuously on 	Boot phase, searching for network
		Fault state
		SIM/PIN error
		Field strength ≤ -98 dBm
		-98 dBm < field strength ≤ -83 dBm
		-83 dBm < field strength ≤ -68 dBm
		Field strength > -68 dBm
		CSD connect
<ul style="list-style-type: none"> • Off 	Field strength unknown	
Current Loop	<ul style="list-style-type: none"> • Green • Off 	CL meter(s) is/are connected or CL interface is short-circuited
		Current loop is interrupted

2.5 Connections on the terminal block, RJ45 jack

The ZDUE-GSM-PLUS-V is connected to the power supply, and the meters are connected to the ZDUE-GSM-PLUS-V, by means of the 9-pole terminal block (power supply, auxiliary voltage, CL, RS-485) and an RJ45 jack (RS-232).

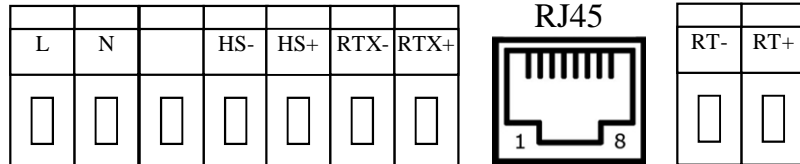

Terminal block:

PIN no.	Signal	Function/Comment
1	L	Mains voltage connection
2	N	Mains voltage connection
3		Not used
4	HS-	Auxiliary voltage -
5	HS+	Auxiliary voltage +
6	RTX-	Current Loop CL1 -
7	RTX+	Current Loop CL1 +
8	RT-	RS-485 RT-
9	RT+	RS-485 RT+

RJ45:

2	DSR	Positive RS-232 voltage (output; always active)
4	GND	Signal GND / cable shield
5	TxD	RS-232 TxD (output)
6	RxD	RS-232 RxD (input)

3 Setup

To put the ZDUE-GSM-PLUS-V into operation, proceed as follows:

	Page
1. Read safety instructions at the beginning of this document	3
2. Insert SIM card	16
3. Connect meter(s)	17
4. Fit and connect antenna	18
5. Connect the ZDUE-GSM-PLUS-V to the power supply	17
6. If necessary, configure the ZDUE-GSM-PLUS-V (e.g. set date and time)	19

3.1 Inserting the SIM card



Warnung

Do not under any circumstances insert or remove the SIM card during operation!

PIN

By factory default setting, the ZDUE-GSM-PLUS-V accepts SIM cards with the PIN **0000**

If your SIM card has a different PIN, you can change the setting of the ZDUE-GSM-PLUS-V to the PIN of your SIM card in parameter class 79 (see chapter 3.6).

Alternatively, you can change the PIN using a mobile telephone.

With some network operators it is also possible to switch off the PIN query of the SIM card. In this case it does not matter what the PIN is, because it is ignored.

To insert the SIM card, proceed as follows:

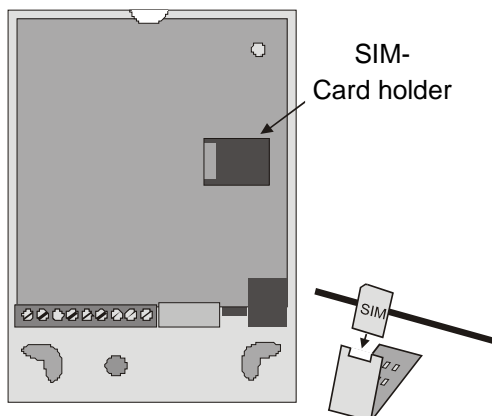

1. If the ZDUE-GSM-PLUS-V is connected to the power supply, disconnect all poles.
2. Loosen the screw on the terminal cover and remove the terminal cover.
3. Then remove the device cover.
4. Open the SIM card holder and slide the SIM card into the flap of the holder. When the SIM card holder is closed, the gold-plated contacts of the SIM card must be in contact with the gold-plated contacts of the holder.
5. Close the flap of the SIM card holder and lock the flap by carefully sliding leftwards. You will feel it latch into place.
6. Re-attach the device cover and the terminal cover.

3.2 Connecting the meters

The ZDUE-GSM-PLUS-V has the meter interfaces described below. Connect the meters to the terminal block as shown in the illustrations. All of the interfaces can be used at the same time.

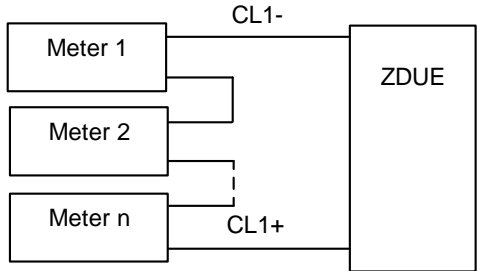
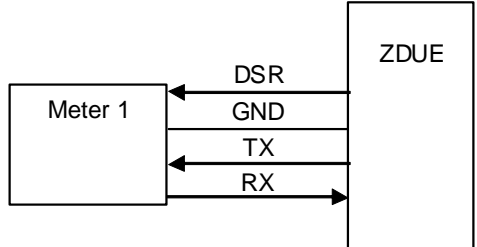
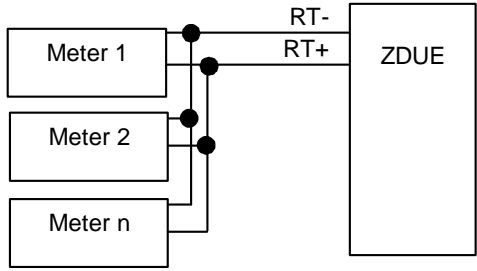
<p>CL1 interface</p> <p>This 20mA current loop interface is used to connect meters with a current loop according to DIN EN 62056-21. Some 4 meters can be connected to this interface.</p> <p>Further information: → Page 21</p>	
<p>RS-232 interface</p> <p>This is used to connect a meter with an interface according to V.24/V.28.</p> <p>Only 1 meter can be connected to this interface.</p> <p>Further information: → Page 22</p>	
<p>RS-485 interface (2-wire)</p> <p>This is used to connect meters with an RS-485 interface.</p> <p>Up to 32 transceivers (meters) can be operated on the bus.</p> <p>The bus connection is fitted with a $Z=120\ \Omega$ (nominal) terminator (RT+ to RT-) and the cable length is limited to 1000m.</p> <p>The interface is isolated from the mains connection.</p> <p>Further information: → Page 22</p>	

3.3 Connecting the ZDUE-GSM-PLUS-V to the power supply

Connection to the power supply is via terminals L and N of the terminal block. These terminals are dimensioned for lines with a cross-section of up to 1.5 mm²

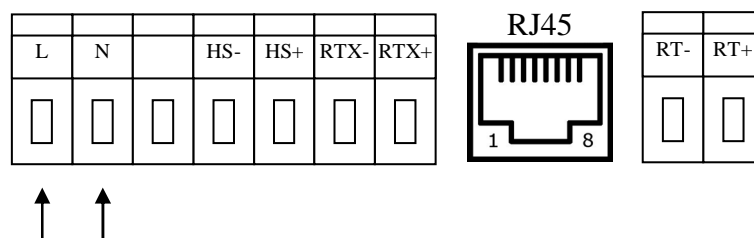

The ZDUE-GSM-PLUS-V can be operated with either AC or DC voltage.

Power supply	Nominal values	Maximum values
AC voltage:	100VAC to 230VAC without changeover (50/60 Hz)	76VAC to 253VAC
DC voltage (protected against polarity reversal):	60VDC to 100VDC without changeover	54VDC to 110VDC

The device conforms to protection class 2. The power supply to the interfaces is electrically isolated from the electronics.

3.4 Fitting and connecting the antenna

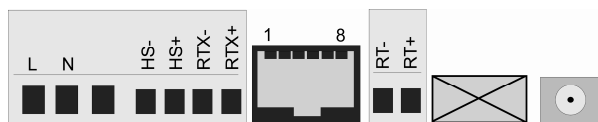

Antenna connection

The antenna is connected to the type SMA antenna jack. The position of the antenna connection may vary depending on the device type.

The antenna must be installed in such a way that adequate signal quality is achieved. Make sure that there are no large metal objects in close to the antenna (e.g. reinforced concrete), as they may have an adverse effect on the signal quality.

If an exterior antenna is mounted out of doors, its support bracket must be earthed for protection against lightning. Have this work done by qualified personnel!

Observe the instructions included with your antenna.

Antenna characteristics

The antenna that is used should have an impedance of about 50 ohms. The antenna must be adapted to the frequency bands of the GSM network operator you have chosen: 850 MHz, 900 MHz, 1800 MHz or 1900 MHz.

In Europa and China GSM 900MHz and DCS 1800MHz are used, in USA GSM 850 MHz and PCS 1900 MHz are used. Please ask your network operator.

The match (VSWR) of the antenna must be 1:2.5 or better.

Use only antennas from the accessories for the ZDUE-GSM-PLUS-V. Other antennas could interfere with product characteristics or even lead to defects.

3.5 Configuring the device if necessary

Basic settings as shipped	<p>The ZDUE-GSM-PLUS-V is shipped with a predefined factory setting. Depending on requirements, it may need to be reconfigured. This can be done :</p> <ul style="list-style-type: none"> <input type="checkbox"/> remotely via a CSD connection <input type="checkbox"/> locally via the RS-232 interface (if no active CSD connection is present).
Configuration options	<p>Among other things, the password protection, interface speeds, data formats and the PIN that is to be used can be parameterised.</p> <p>For detailed information on parameterisation, see the chapter 6.</p>

3.6 Parameterising the SIM PIN

Parameterisation options	<p>The PIN can be set</p> <ul style="list-style-type: none"> <input type="checkbox"/> remotely via a CSD connection <input type="checkbox"/> locally via the RS-232 interface (if no active CSD connection is present). <p>For detailed information on parameterisation, see the chapter , see the chapter 6.</p>
SIM cards that have no PIN	<p>With SIM cards that have no PIN, the PIN query is skipped; the GSM module does not wait for the PIN to be entered, but rather tries to check into the GSM network directly.</p>
Response to a correct SIM PIN	<p>If the PIN function of the SIM card being used is activated, and the PIN on the SIM card being used agrees with the parameterised PIN, then the device automatically tries to check into the GSM network.</p>
Response to an incorrect SIM PIN	<p>If the PIN verification fails, it is repeated one time. If the repeated PIN verification also fails, the device is blocked for further attempts (PIN ERROR status), meaning that operation is no longer possible even with a SIM card with the correct number. The Status/Error LED indicates a SIM/PIN error (see 2)</p> <p>This status is retained after the power supply is disconnected and reconnected. This prevents the SIM card from being blocked if a third failed attempt is made, after which it could only be unblocked using the PUK (Personal Unblocking Key).</p>
Unblocking the device	<p>To unblock the ZDUE-GSM-PLUS-V, a SIM card with a deactivated PIN function must be inserted in the device. After starting, the device attempts to check into the GSM network, and the PIN ERROR status is also reset.</p> <p>Alternatively, the ERROR status can be reset using the service command for setting a new PIN (see 6.5.7). This simultaneously sets the PIN parameterised in the device.</p>

4 Interfaces

4.1 The GSM interface

- Characteristics** Communication with the GSM network takes place via an integrated GSM module. Data transmission is according to the following standards:
- GSM Rec. 7.02 asynchronous, RLP acc. to GSM Rec. 4.22,
 - Analogue modem type V.32 or ISDN type V.110

4.2 Meter interfaces

Characteristics

The meter interfaces of the ZDUE-GSM-PLUS-V are all parameterised jointly, i.e. so that all of the interface parameter settings apply equally for all meter interfaces.

The following values are supported by the meter interfaces:

Data format: Default: 7E1

 Settable: 7E1, 8N1, 8E1

Handshake: No hardware/software handshake.

Interface speed: Default: 300 baud (Mode C)

 Settable: 300, 600, 1200, 2400, 4800, 9600, 19200, 38400 baud.

- ➔ The speed of the meter interfaces should not exceed the speed of the GSM connection (9600 bit/s), because otherwise data loss may occur.

Number of meters

Meters can be connected to and operated on all of the interfaces at the same time, but only up to the specified maximum numbers.

In communication with the connected meters, all of the interfaces are addressed simultaneously, i.e. no application (e.g. control centre) can address any interface selectively. This means that unique addressing of the meters is essential in order to prevent the transfer of data by several meters at the same time.

Procedure for communication between control centre and meter

Fixed baud rate:

The speed is set to a fixed value via a parameter setting. The respective meters that are communicating and the control centre connected via modem exchange the data at the selected speed, i.e. the ZDUE-GSM-PLUS-V works transparently. The speed does not exceed the GSM speed (9600 bit/s), or may be less.

Variable baud rate:

Corresponds to the baud rate changeover as per Mode C according to DIN EN 62056-21.

The starting speed is 300 baud. The speed is increased if the communicating meter requests it from the corresponding interface, and the interface confirms the requested baud rate. If there is no confirmation, the communication continues at the current speed.

4.3 Interface types

CL1 (Optional)

Interface CL1 conforms to the current loop interface according to DIN EN 62056-21.

This is an active 20mA interface with a 2-wire connection via the terminals RTX- and RTX+ (terminals 6 and 7) of the terminal block.

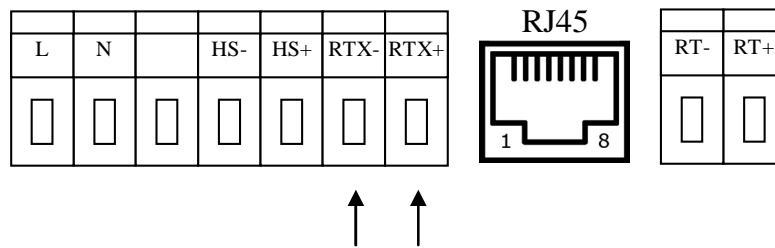

Maximum that can be connected: 4 meters

Attention

If the CL interface is not used, it must be short-circuited with a wire jumper, since otherwise the other interfaces of the ZDUE-GSM-PLUS-V will not function.

The interface is isolated from the modem by means of an optocoupler.

When reading a meter, all of the characters transmitted to the meter are transmitted back as an echo via the CL1 interface. These characters are normally transmitted to the higher-level system. The echo is suppressed by the modem.

RS-485

The meters are connected to terminals RT- and RT+ (terminal 8, 9) of the terminal block.

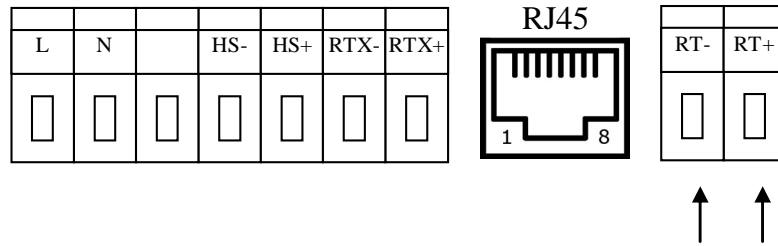

Maximum that can be connected: 32 meters

The bus connection is fitted with a 120 ohm (nominal) terminator and the cable length is limited to 1000m.

The interface is isolated from the mains connection.

RS-232

The interface conforms to the V.24 / V.28 specification.

Connection of a meter to the RS-232 interface is via the RJ45 jack next to the terminal block (assignment see 2.5).

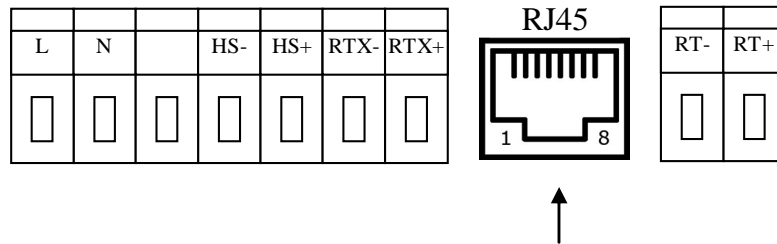

Maximum that can be connected: 1 meter

In some circumstances connection may require the use of an adapter cable (for example D-Sub9 DE-9 to RJ-45).

The interface is isolated from the mains connection.

Local configuration:

The ZDUE-GSM-PLUS-V can be configured with a computer connected to this interface.

The setting for this is: 19200 baud, 8N1.

The RS-232 interface is automatically set to these values as soon as no GSM connection is present.

4.4 Auxiliary power source

Auxiliary power source (9V)

The ZDUE-GSM-PLUS-V provides a 9V auxiliary power source. Connection is via terminals HS-, HS+.

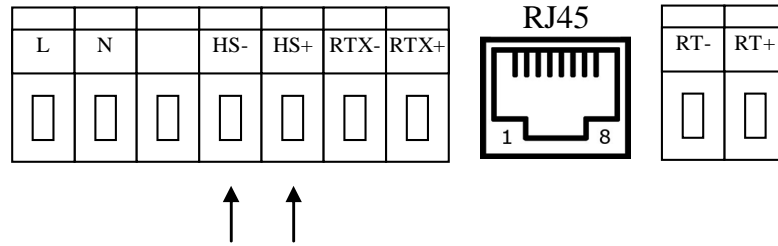

The auxiliary power source is not available in all variants of the ZDUE-GSM-PLUS-V.

The auxiliary power source may not be loaded with more than 100mA.

5 Operation

5.1 AT Mode

To enter the AT mode disconnect the device from mains and set the DIP switch (2.3) to „ON“. Connect the device to mains again.

If the AT mode is active, the GSM module inside the ZDUE-GSM-PLUS-V can directly be controlled by AT-Befehl entered at the meter interface. By it the ZDUE-GSM-PLUS-V can for example be used as a GSM terminal adapter for data connections via the GSM network.

After pushing the service button while the ZDUE-GSM-PLUS-V is in the meter mode and switching back into the the AT mode, the meter interface is setup to:

19200 bit/s, 8N1

Swich into the meter mode to change the bitrate (eg. From 19200 bit/s to 9600 bit/s). Switch back into the AT mode.

If in meter mode after pushing the service nbutton another bitrate (start bit rate) is selected, this bitrate is also vald after switching into the AT mode

In AT-Modus always the character format 8N1 is used.

A remote configuration is not possible in AT mode.

To activate the automatic answer, please enter the AT commad ATSO=1.

Attention

Please take care, that the hardware handshake (RTS/CTS) of the terminal software needs to be switched off.

Attention

Do not modify in any case the baudrate of the GSM engine by AT command!

5.2 Meter Mode

To enter the meter mode disconnect the device from mains and set the DIP switch (2.3) to „OFF“. Connect the device to mains again.

In the meter mode the ZDUE-GSM-PLUS-V accepts automatically incoming calls from the central station and connects transparently the connected meters with the central station. The start bitrate at the meter interfaces is set by parameters to a fix value. The meter which communicates and the central station exchange directly the data, i.e. the ZDUE-GSM-PLUS-V just passes through the data between central station and meter.

If EN 62056-21 mode C is activated, the ZDUE-GSM-PLUS-V adapts the bitrate, but does not modify the data content.

The ZDUE-GSM-PLUS-V can be configured remotely via the GSM connection using configuration commands in accordance to DIN EN 62056-21.

5.3 Controlling according to EN62056-1

Control characteristics

The ZDUE-GSM-PLUS-V controls the communication between the control centre and the meters that are connected to the ZDUE-GSM-PLUS-V in accordance with protocol EN 62056-21 (Annex A):

- in A/C mode,
- in data readout and programming mode
- including data saving (receiving) and acknowledgement.

The starting baud rate and the data format can be set for the following interfaces: CL1 (Current Loop interface), RS-232, RS-485

Please note that these meter interface settings apply equally for all interfaces.

- In mode C-Operation the baud rate is changed over according to the baud rate ID contained in the acknowledge telegram of the control centre.

Detecting the end of a communication cycle

When reading data, the end of a communication cycle is detected when

- ≥ 3 seconds no meter data is received (Mode A/C \rightarrow timeout)
- the sequence 'CR LF ETX' is detected (Mode C \rightarrow regular end)

In programming mode, the end of a communication cycle is detected when

- a 'Break' telegram is detected (Mode A/C \rightarrow break).

When a communication cycle is completed, the connection is terminated and the baud rate of the serial interface driver of the meter interfaces is reset to the parameterised start value.

Regular connection termination

Termination of connection after transfer timeout:

The ZDUE-GSM-PLUS-V terminates a regular data connection after the end of the transfer timeout. What this means is: For an existing connection, if no data transfer takes place between the control centre and the ZDUE-GSM-PLUS-V or the meters connected to the ZDUE-GSM-PLUS-V within the specified timeout (default: 99 seconds), then the ZDUE-GSM-PLUS-V terminates the connection.

Termination of connection by the control centre:

The control centre can itself terminate a connection at any time.

6 Configuration

The most important configurable settings and functions	Security settings
	Password
	Data format and transmission speed of the meter interfaces
	GSM module reset

6.1 Configuration by software

Configuration is performed with the software that is used for operation of the control centre or a configuration software (e.g. Dr. Neuhaus ZDUEset). Parameterisation commands are transmitted to the ZDUE-GSM-PLUS-V with the aid of this software.

The software commands are described starting on page 33.

The parameterisation commands can be transmitted to the ZDUE-GSM-PLUS-V via the GSM network (remote configuration) or directly via the RS-232 interface (local configuration).

Remote configuration via the GSM network

Remote configuration is performed by the control centre, which transmits parameterisation commands to the ZDUE-GSM-PLUS-V via the GSM network. Transmission takes place according to DIN EN 62056-21 with BCC secured protocol.

The parameterisation commands must be transmitted explicitly to the address of the ZDUE-GSM-PLUS-V.

The following device address is preset at the factory: **99999999**

The device address is configurable. It can contain up to 16 characters; numbers and letters are permitted.

Local configuration

The device can also be configured with the aid of a computer that is connected via its COM port directly to the RS-232 interface of the ZDUE-GSM-PLUS-V.

Precondition:

No GSM connection exists between ZDUE-GSM-PLUS-V and control centre.

GSM offline status: Settings of the RS-232 interface

As soon as no GSM connection exists, the RS-232 interface is set by default to the following setting:

19200 baud
8 data bits, No Parity, 1 stop bit

Make sure that on the configuration computer that is connected the settings of the COM port being used agree with this, and switch off all flow controls (hardware (RTS/CTS), XON-XOFF).

If the computer connected to the RS-232 interface transmits prompting telegrams with the device address of the ZDUE-GSM-PLUS-V (default: **99999999**), the ZDUE-GSM-PLUS-V responds exactly as if it received the prompting telegram from the remote control centre via the GSM network.

During local configuration via the RS-232 interface the ZDUE-GSM-PLUS-V does not accept any calls from the GSM network.

GSM online status: Settings of the RS-232 interface

As soon as a GSM connection is established, the RS-232 interface switches to the bitrate and data format being configured for the meter mode
Factory default is::

300 bit/s, 7E1, Mode C

- The settings of the RS-232 interface for the GSM online status are configurable

Attention

Please note that the RS-232 interface is only used if something is connected to the current loop (it has at least one meter connected or a wire jumper between the two current loop terminals RTX- and RTX+). In this case the current loop LED must light up (see 2.1).

6.2 Parameters

The following table provides an overview of the basic parameter classes contained in the ZDUE-GSM-PLUS-V. These classes are assigned to numbers, which must also be specified in parameterisation commands.

	Class	Permitted access types (R=Read/W=Write)
Summer/Winter time changeover times (implemented for compatibility reasons only, see 6.3.1)	54	R/W
Operating parameters	79	R/W

Parameters can only be written by writing a complete class (i.e. an offset and length must also be specified with '0000' in a parameterisation command).

When a class is expanded the new parameters must be appended in order to ensure downward compatibility.

Each parameter class includes a range that is reserved for possible expansions. Parameter expansions that are covered by these reserved ranges do not lead to any incompatibility between different firmware versions. If the expansion space is not sufficient, a new parameter class must be created. This likewise does not lead to any incompatibility, because a command to set/read this new parameter class from an older firmware will be acknowledged with ERROR. The reserved parameter ranges are filled in with '0' (0x30) during communication.

6.3 Parameter classes

In the following the parameters are sorted by classes and shown in the same way as their notation in parameterisation commands. The respective **factory configuration** is highlighted in **bold**. The specifications *Offset*, *Len* and *Values (ASCII)* have the following meanings

Offset	Contains the relative address of a parameter within the parameter class, relative to the class structure.
Len	Reflects the number of ASCII characters that are necessary to depict the parameter during communication. For strings only the number of ASCII characters defined with 'String Length' is significant (decimal-coded); any string range that is not used must be filled in.
Values (ASCII)	Contains permissible values (ranges) for the individual parameters during reading (W1 command) and reading by means of an R3 command.

6.3.1 Parameter class 54

This class is implemented only for compatibility reasons. In other models it specifies the changeover times of the clock from summer time to standard time and from standard time to summer time. However, because the ZDUE-GSM-PLUS-V does not have a real-time clock, the parameter class 54 has no significance for operation of the ZDUE-GSM-PLUS-V. The parameters of this class are read-only.

6.3.2 Parameter class 79

This class describes the general operating parameters of the ZDUE-GSM-PLUS-V. It is defined as an open class, i.e. data sets that are longer than what is defined here are accepted. The non-specified values are ignored in evaluation by the device. When the parameters are read only the specified values are output.

Length of the class 79 data set: 124 bytes

Class 79 Parameters	Offset	Len	Values (ASCII)	Description
String length Power supply company identification	0	2	'01' .. '16'	Factory configuration: '08'
Power supply company identification	2	16	'..' '~', (0x20..0x7E)	'00000000' / Power supply company identification of the

Class 79 Parameters	Offset	Len	Values (ASCII)	Description
				ZDUE-GSM-PLUS-V in the accounting data set.
String length of device address (IEC address)	18	2	'01' .. '16'	Factory configuration: '08'
Device address ZDUE-GSM-PLUS-V	20	16	('0' .. '9', 'a' .. 'z', 'A' .. 'Z')	'99999999'
String length of set password	36	2	'00' .. '16'	Factory configuration: '08'
Set password	38	16	' ' .. '~' (20h .. 7Eh) without '(' , ')'	'00000000'
Control centre password active	54	1	'0' '1'	No password protection Password without callback
String length of control centre password	55	2	'00' .. '16'	Length of the control centre password
Control centre password	57	16	' ' .. '~' (20h .. 7Eh)	Factory configuration: empty
String length of communication ID	73	2	'01' .. '16'	Factory configuration: '15'
Communication ID	75	16	' ' .. '~' (20h .. 7Eh)	'1KGL923380R0003'
Data format to meter interface	91	1	'0' '1' '2'	7 data bits, Even Parity, 1 stop bit 8 data bits, No Parity, 1 stop bit 8 data bits, Even Parity, 1 stop bit
Mode C monitoring	92	1	'0' '1'	Meter changeover, external meters according to IEC61107 as per Mode C is monitored Purely transparent data operation with fixed baud rate acc. to start baud rate.
Transfer timeout [seconds]	93	2	'10' to '99'	10 to 99 seconds factory configuration: '99'
Call answering delay	95	2	'01' .. '15'	is ignored (always '01')
Start baud rate	97	1	'0' '1' '2' '3' '4' '5' '6' '7' '8'	300 baud 600 baud 1200 baud 2400 baud 4800 baud 9600 baud 19200 baud 38400 baud 57600 baud (optional)
Bearer service	98	2	'00' '07' '08' '09' '10'	Autobauding, 9600bps(V.32), 14400bps(V.34), 9600bps(V.110), 14400bps(V.110)
Data saving/compression	100	1	'0' '1'	RLP non-RLP
Country code	101	2	'00'	Reserve, not in use

Class 79 Parameters	Offset	Len	Values (ASCII)	Description
Daily watchdog	103	1	'0' '1'	activated, the device notices the watchdog no daily watchdog activated
Time for daily watchdog	104	4	'2100'	The watchdog interval starts daily at this time, relative to the device time
Interval for watchdog	108	1	'0' '1' '2' '3' '4' '5'	every 24 hours watchdog every 12 hours watchdog every 6 hours watchdog every 3 hours watchdog every 2 hours watchdog every 1 hour
Data format to control centre ¹	109	1	'0' '1'	Data format 7E1 (simulated) Data format 8N1
String length of PIN	110	1	'0' .. '9'	Factory configuration: '4'
PIN ²	111	9	('0' .. '9')	Factory configuration: '0000'
Operator Set Mode	120	1	'0' '1' '4'	Automatic: roaming permitted Manual: no roaming permitted! Manual / Automatic: Roaming permitted, but GSM module is if necessary stopped cyclically (Operator Set Delay) in order to check into the home network (GSM Net ID = first 5 digits of the IMSI).
Operator Delay Set	121	2	'15' .. '99'	Interval [in minutes] for module request 'Operator Select', if the parameterised and actual operator are different.
Cyclical query of the call forwarding	123	1	'0' '1'	Query of the call forwarding is active Query of the call forwarding is passive

¹ In the reception path the ZDUE-GSM-PLUS-V evaluates all characters in the data format 7N. This applies to Mode C monitoring and the addressing and communication with the ZDUE-GSM-PLUS-V (address "99999999"). The set data format is used in the transmission path to the control centre (regardless of the application interface). A consequence of this function is that it does not matter for the parameterisation of the ZDUE-GSM-PLUS-V which data format is set at the control centre or in the modem.

² As long as the device has the status "PIN without errors", the PIN is changed accordingly both in the device and on the SIM. The change is performed in service operation immediately after the transfer command for parameters. In CSD operation the PIN is saved on the SIM and in the device immediately after it is applied. The new PIN is saved in the device parameters only after the PIN has been successfully changed on the SIM.

6.4 Register data set of the ZDUE-GSM-PLUS-V

6.4.1 General

The ZDUE-GSM-PLUS-V contains a short set for register data. Output is made using the DIN EN62056-21 protocol. The register data set is structured according to the following table.

EDIS identifier	Field length	Format	Function
1-1:F.F	8	Hexadecimal	Error status
1-1:0.0.0	16 (def. 8)	Character string	Power supply company identification 1
1-1:0.2.0	8	Character string	Firmware version of the ZDUE-GSM-PLUS-V
1-1:0.9.1	6	hhmmss	Time
1-1:0.9.2	6	YYMMDD	Date
1-1:C.91.0	15	Character string	Firmware version of the GSM module
129-72:23.7.0	15	Character string	Current IP address in GPRS operation ³

The register data set of the ZDUE-GSM-PLUS-V receives the values for time and date that have previously been written with the corresponding set command. If no time or no date has been set yet, or if the device was deenergised, then "0000000" is output as the time and/or date respectively.

Example: Accounting data of the ZDUE-GSM-PLUS-V

```

1-1:F.F      (00000005)      Error status
1-1:0.0.0    (12345678)      Power supply company ID
1-1:0.2.0    ( 4.016)       Firmware version of the ZDUE
1-1:0.9.1    (135224)       Time (hhmmss)
1-1:0.9.2    (110326)       Date (yymmdd)
1-1:C.91.0   (REVISION 01.002) Firmware version of GSM module
129-72:23.7.0 ( )          [own IP address]3
!
T

```

³ This register is only relevant for GPRS operation in the ZDUE-GSM-PLUS-V (see Section 7.4.4). If the ZDUE-GSM-PLUS V is not operated in GPRS mode, it does not contain any value (empty brackets). If the ZDUE-GSM-PLUS V is operated in GPRS mode, but it has not received any IP address from the provider, then the register is given the value "000.000.000.000".

6.4.2 Format of the error status

The value is the hexadecimal representation of a 32-bit number that is composed of the following status bits (in brackets is the bit no. in the operation status word, see the section *Status* commands):

Bit 0	(Bit 08):	Power return
Bit 1	(Bit 09):	reserved "0"
Bit 2	(Bit 10):	Parameter reloaded
Bit 8	(Bit 04):	Parameter checksum error
Bit 16	(Bit 05):	Parameter read/write error
Bit 17	(Bit 06):	reserved "0"
Bit 18	(Bit 07):	reserved "0"
Bit 24	(Bit 00):	reserved "0"
Bit 25	(Bit 01):	reserved "0"
Bit 26	(Bit 02):	reserved "0"

6.5 Communication commands according to DIN EN 62056-21

The following sections document the commands supported by the ZDUE-GSM-PLUS-V. The data set elements it contains are described in the following.

The command descriptions use symbolic data set elements (e.g. for time stamps). Their structure is the same for all command categories.

- Time stamp
ZS7: yhhmmss

y	= time zone	(0=winter time, 1=summer time)
hh	= hour	(00..23)
mm	= minute	(00..59)
ss	= second	(00..59)
- Time stamp
DS7: yYYMMDD

y	= time zone	(0=winter time, 1=summer time)
YY	= year	(00..99)
MM	= month	(01..12)
DD	= day	(01..31)
- Set password: String with max. 16 characters, with the exception of the character '(', ')', '/', '!' or empty string

6.5.1 Error messages

In unusual circumstances the ZDUE-GSM-PLUS-V answers a command with an error message: <STX>(ERRORnn)<ETX><BCC>

The following error numbers 'nn' can be generated by the ZDUE-GSM-PLUS-V in this case:

Error number (nn)	Error
00	Invalid command (data set structure, content)
01	Unknown command (command ID, command type ID)
02	
03	
04	Invalid class
05	
06	
07	
08	
09	
10	
11	Invalid time/date (impermissible values)
12	
13	
14	Serial number has already been set [W1-S96(20)(<data>)]

6.5.2 Set password

For the execution of various commands, the transfer of a set password (as a 2nd data set) is necessary. Depending on the parameterisation, the following cases can arise in communication between ZDUE-GSM-PLUS-V and control centre:

- No set password parameterised in the ZDUE-GSM-PLUS-V (string length = 0):

In this case the ZDUE-GSM-PLUS-V will not perform any evaluation of the transmitted set passwords (all password-protected commands can be executed!).

In this case, the request to transmit the password (P0 operand) when programming mode is activated may be answered with the password command (P1 command, password as desired). The control centre can, however, alternatively also continue the communication with the transfer of a different permissible VDEW command.

- Set password parameterised in the ZDUE-GSM-PLUS-V (default: '00000000')
All of the passwords transmitted by the control centre must be the same as the ones that were parameterised, otherwise the communication will be terminated by the ZDUE-GSM-PLUS-V by means of a break command. The request to transmit the password (P0 operand) when programming mode is activated must be answered with the password command (P1 command). The direct transmission of a different VDEW command is not permitted.

6.5.3 Parameterisation commands

The setting and reading of the parameters is performed via W1/R3 commands (ASCII-coded characters).

The **class** is used to select the individual parameter segments; the command parameters '**offset**' and '**length**' can in general be used to access individual parameter or parameter ranges. This is, however, not supported by the ZDUE-GSM-PLUS-V; the classes can only be read or written completely ('offset' and 'length' of the class equal to '0000').

W1 commands:

1. Write class (completely)

Command format: <SOH>**W1**<STX>**C<class>**00000000(<data>)
(set password)<ETX><BCC>

Example: Setting the parameters of the subgroup parameter class 79 to the following values:

Power supply company identification: '12345678'
Device address: '74747474'
Set password: '18871887'
Control centre password act.: '0'
Control centre password: 'PW0'
Communication ID: '1KGL923380R0003'
Data format to meter: '1'
Mode C monitoring: '1'
Transfer timeout: '99'

...

(The other parameters correspondingly)

```
LS    /?99999999!<CR><LF>
ZDUE  /ABB61KGL923380R0003<CR><LF>
LS    <ACK>061<CR><LF>
ZDUE  <SOH>P0<STX>(00000001)<ETX><BCC>
LS    <SOH>P1<STX>(00000000)<ETX><BCC>
ZDUE  <ACK>
LS    <SOH>W1<STX>C7900000000(08123456780000000000874747
4740000000008188718870000000000PW0000000000000151KG
923380R00020119901600000021000140000000001150)(000000
00)<ETX><BCC>
ZDUE  <ACK>
```

After this command is carried out, the data are initially stored in the volatile memory of the ZDUE-GSM-PLUS-V. In order to transfer them to non-volatile memory, the parameter transfer command **W1P01()** (see Section 6.5.4) must be executed.

R3 commands:

1. Read class in partial blocks

Command format: <SOH>**R3**<STX>**C**<class>00000000()<ETX><BCC>

Reply format: <STX>0000(<data set>)[<EOT> | <ETX>]<BCC>

0000 = Offset (ASCII characters hexadecimal-coded)

<data set> = data of the class (max. 64 ASCII characters per partial block)

Example: Reading of class 79 with offset '0000', length '0000' (reading of the operating parameters -> multiple partial blocks required):

```

LS    <CR><LF>
ZDUE  /ABB61KGL923380R0003<CR><LF>
LS    <ACK>061<CR><LF>
LS    <CR><LF>
ZDUE  <SOH>P0<STX>(00000001)<ETX><BCC>
LS    <SOH>P1<STX>(00000000)<ETX><BCC><CR><LF>
ZDUE  <ACK>
LS    <SOH>R3<STX>C7900000000()<ETX>,<CR><LF>
ZDUE  <STX>0000(080000000000000000000000089999999900000000
      800000000000000000003PW00000)<EOT><BCC>
LS    <ACK><CR><LF>
ZDUE  <STX>0040(000000000151KGL923380R000300099015000000
      21000040000000001150)<ETX><BCC>
    
```

6.5.4 Parameter transfer command

In order for newly written parameters to be transferred at a specific point in time, the following command is defined.

Executing this command causes the data of the previously transmitted command "Write class" to be transferred to the non-volatile memory. The old parameters remain active before this command is executed.

If the data are read before transfer by means of this command, the old values will be output!

The transmission of a *break* deletes the data set temporarily in the device via class write commands. This way faulty "Write class" commands can be undone, so long as the W1 command defined here has not been transmitted. Moreover, the temporary data are discarded by a disconnect or the occurrence of an inactivity timeout.

Command format: <SOH>**W1**<STX>**P01**()(set password)<ETX><BCC>

6.5.5 Time/date commands

The time and date commands have no function in the ZDUE-GSM-PLUS-V. They are implemented for reasons of compatibility with other devices and control centre programs.

The reading of the time and/or date from the ZDUE-GSM-PLUS-V makes available the values that were written to the device previously with the commands *Set time* and/or *Set date*. These data are saved in the device only in volatile memory, and thus are no longer available after the power supply is disconnected.

If no time is set, "0000000" is returned as the time; if no date is set, "0070101".

Setting the time:

Command format: <SOH>**W5**<STX>**0.9.1**(ZS7)(set password) <ETX>
<BCC>

Setting the date:

Command format: <SOH>**W5**<STX>**0.9.2**(DS7)(set password) ETX>
<BCC>

Reading the time:

Command format: <SOH>**R5**<STX>**0.9.1**()<ETX><BCC>

Reply format: <STX>0.9.1(ZS7)<ETX><BCC>

Reading the date:

Command format: <SOH>**R5**<STX>**0.9.2**()<ETX><BCC>

Reply format: <STX>0.9.2(DS7)<ETX><BCC>

6.5.6 Status commands

Events and error messages are recorded in an "operation status word" in the ZDUE-GSM-PLUS-V. This is stored in volatile RAM, and is thus lost in the event of a power failure. The status word can be read from the device in order to determine the current operating status.

Bit in status word	Indicated fault state / event
Bit 0	<i>Reserved</i>
Bit 1	<i>Reserved</i>
Bit 2	<i>Reserved</i>
Bit 3	<i>Reserved</i>
Bit 4	Parameter checksum faulty (EEPROM)
Bit 5	EEPROM read/write error
Bit 6	<i>Reserved</i>
Bit 7	<i>Reserved</i>
Bit 8	Power return
Bit 9	<i>Reserved</i>
Bit 10	<i>Reserved</i>
Bit 11	<i>Reserved</i>
Bit 12	<i>Reserved</i>
Bit 13	<i>Reserved</i>
Bit 14	<i>Reserved</i>
Bit 15	<i>Reserved</i>

Additional status information that can be read from the ZDUE:

- GSM field strength
- GSM network operator ID (e.g. 26201 for T-Mobile)
- GSM location area ID
- GSM cell ID
- IMEI (International Mobile station Equipment Identity): Serial number of the GSM module
- IMSI (International Mobile Subscriber Identity): ID number of the SIM card

These value are queried from the ZDUE-GSM-PLUS-V via service command (see 6.5.7).

The ZDUE-GSM-PLUS-V enables the reading and resetting of the status word. During reading the highest-value bit is transmitted first; each bit is represented by an ASCII character '0' or '1'.

Read status word:

Command format: <SOH>**R3**<STX>**S70()**<ETX><BCC>

Response: <STX>S70(b₁₆b₁₅b₁₄ b₀)<ETX><BCC>

b_{nn} : '0' = event/status has not occurred / inactive
 '1' = event/status has occurred / active

Example: Bit 8 (power return) is set in the status word.

```

LS    /?99999999!<CR><LF>
LS    <CR><LF>
ZDUE /ABB61KGL923380R0003<CR><LF>
LS    <ACK>061<CR><LF>
ZDUE <SOH>P0<STX>(00000001)<ETX><BCC>
LS    <SOH>P1<STX>(00000000)<ETX><BCC><CR><LF>
ZDUE <ACK>
LS    <SOH>R3<STX>S70()<ETX><BCC><CR><LF>
ZDUE <STX>S70(0000000100000000)<ETX><BCC>
LS    <SOH>B0<ETX><BCC><CR><LF>

```

Reset the status word:

Command format: <SOH>**W1**<STX>**S70()**<ETX><BCC>

6.5.7 Service commands

W1 commands:

Reset parameters to factory configuration:

This command is used to load the factory parameters. All customer-specific settings are overwritten.

Command format: <SOH>**W1**<STX>**S98()**<ETX><BCC>

- The overwritten parameters are saved in non-volatile memory. The device is then automatically rebooted.
- This command is also permitted via the network (GSM interface, GPRS).
- This command is executed immediately after receipt (without transmitting an additional break).
- The manufacturer passwords and the manufacturer device addresses are not reset by this command.

Remote reset of the ZDUE-GSM-PLUS-V

This command provokes a warm restart of the device. The command leads to a watchdog reset followed by a restart of the firmware. No changes are made to the parameters.

Command format: <SOH>W1<STX>S92() (<set password>)<ETX><BCC>

Response: <ACK>

This command is also permitted via the GSM interface

Write PIN

This command sets the PIN in the device to the new value. The PIN on the card is not changed. Any PIN fault status that is present is cleared by this command.

Command format: <SOH>W1<STX>S93(<PIN_Len><PIN>)(<set password>) <ETX><BCC>

Response: <ACK>

The parameters have the following meaning here:

PIN_Len: Length of the PIN

PIN: PIN to be set

Set password: Set password parameterised in the ZDUE-GSM-PLUS-V.

This command is also permitted via the GSM interface.

R3 commands:

Read parameter checksum

Command format: <SOH>R3<STX>S61()<ETX><BCC>

Response: <STX>S61(cccc)<ETX><BCC>

cccc : Hex-coded 16-bit parameter checksum

This command is also permitted for the GSM interface.

Read firmware version of the ZDUE

Command format: <SOH>R3<STX>S63()<ETX><BCC>

Reply (example): <STX>S63(ZDUE_PLUS_V_V4.017)<ETX><BCC>

This command is also permitted for the GSM interface.

Read firmware version of the GSM module

Command format: <SOH>R3<STX>S64()<ETX><BCC>

Reply (example): <STX>S64(REVISION 01.002)<ETX><BCC>

This command is also permitted for the GSM interface.

Read version of the booter

Command format: <SOH>R3<STX>S96(14)<ETX><BCC>

Reply (example): <STX>S96(14)(<data>)<ETX><BCC>

This command is also permitted for the GSM interface.

Read position of the DIP switch/parameter status

Command format: <SOH>**R3**<STX>**S96(15)**<ETX><BCC>

Reply (example): <STX>S96(15)(ccccp)<ETX><BCC>

The parameters have the following meaning here:

cccc : Hex-coded 16-bit output
 p : Parameter status flag:
 0 : User parameterisation active
 1 : Default parameterisation active

This command is also permitted for the GSM interface.

Read GSM operating/module parameters:

Command format: <SOH>**R3**<STX>**S65()**<ETX><BCC>

Reply (example): <STX>S65(dB)(Net-ID)(location)(Cell ID) (IMEI) (IMSI)
 <ETX><BCC>

The parameters have the following meaning here:

dB GSM field strength (3-digit, decimally coded, e.g.: '075' => -75dBm, 'na' => not available)
 Net ID Network ID of the GSM network operator (max. 6 digits, e.g.: '26202'),
 Location GSM Location Area ID (max. 4-digit, hex-coded),
 Cell ID GSM Cell D (max. 4 digits, hex-coded),
 IMEI Serial number of the GSM module (International Mobile station Equipment Identity, max. 20 digits),
 IMSI ID number of the SIM card (International Mobile station Equipment Identity, max. 20 digits).

This command is also permitted for the GSM interface.

Example (reply): <STX>S65(075)(26202)(019B)(6434)(357042000459777) (262023800175922)<ETX>

Read unique serial number:

Command format: <SOH>**R3**<STX>**S96(20)**<ETX><BCC>

Reply (example): <STX>S96(20)(<date>;<Ser-no.>;<Lot no.>)<ETX><BCC>

The parameters have the following meaning here:

Date: Date in the format "YYYYMMDD" (e.g.: 20060830)

Ser. Number Max.12-digit serial no. (ASCII characters), leading zeros allowed

Lot number Max.34-digit lot no. (ASCII characters), leading zeros allowed

This command is also permitted for the GSM interface.

7 GPRS Mode

In GPRS mode it is possible, as an alternative to communication via CSD, to establish a data connection via the GPRS network to the ZDUE-GSM-PLUS-V and the meters connected to it.

In this case the ZDUE-GSM-PLUS-V functions as an IP server to which an IP connection must be established from a client (e.g. a control centre).

Attention

In order to be able to operate the ZDUE-GSM-PLUS-V in GPRS mode, a SIM card enabled for GPRS must be used. Please consult your GSM provider if necessary.

7.1 Configuration

Configuration options

In addition to the configuration options of the ZDUE-GSM-PLUS-V in CSD mode, the ZDUE-GSM-PLUS-V in GPRS mode can be parameterised via an IP connection opened by a client.

Remote configuration via the GSM network

As in the ZDUE-GSM-PLUS-V, see *Remote configuration via the GSM network*, p. 27).

Local configuration

As in the ZDUE-GSM-PLUS-V, see *Local configuration*, p. 27.

Remote configuration via GPRS (fixed IP service)

Configuration is performed using parameterisation software (control centre, configuration tool (e.g. Dr. Neuhaus ZDUEset, etc.)). This transmits the parameterisation commands to the ZDUE-GSM-PLUS-V via the GPRS network. Transmission likewise takes place according to DIN EN 62056-21 with BCC secured protocol.

The parameterisation commands must be transmitted explicitly to the address of the ZDUE-GSM-PLUS-V. The following device address is preset at the factory: **99999999**

The device address is configurable. It contains 16 characters; numbers and letters are permitted.

7.2 Behaviour for the GPRS dial-in

Provided that the parameterisation is correct, normally the device dials into the GPRS network automatically and then sets up the IP server, so long as GPRS mode is activated in class 82.

For example, faults in the GSM network or at the GPRS provider can cause the log-in and dial-in attempts of the ZDUE-GSM-PLUS-V to fail. To prevent the device from trying to establish a connection to the GPRS network continuously (and in some cases incurring costs in the process), the ZDUE-GSM-PLUS-V possesses two timers and a counter that can be used to control its behaviour in the event of such faults. These parameters are contained in parameter class 82 (see 7.4.3):

Counter: Number of dialling attempts to GPRS service before module reset

Timer 1: Connection timeout for a failed GPRS login attempt

Timer 2: Waiting time after x failed GPRS login attempts

Here the ZDUE-GSM-PLUS-V proceeds in two steps. If a GPRS login attempt fails, the number of login attempts defined in *Counter* are repeated at certain intervals (*Timer 1*), until *Timer 2* elapses, after which the device carries out a module reset and the login process starts again from the beginning.

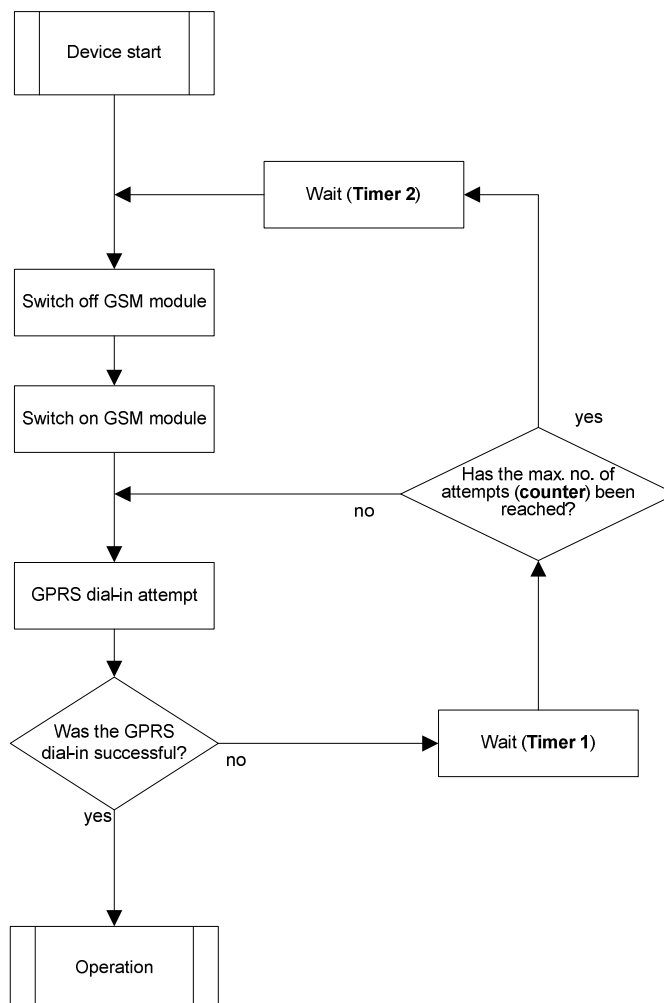

7.3 GPRS Access Parameter (Parameter classes 60 and 61)

The provider-specific GPRS access parameters for two different network operators can be saved in parameter classes 60 and 61. Based on the IMSI of the inserted SIM card, the firmware automatically detects the GSM Net ID (first 5 digits of the IMSI) of the relevant provider and searches for this GSM Net ID in parameter classes 60 and 61. When they are found, the parameters contained in the corresponding class are used.

In the factory configuration these two classes are assigned with the GPRS access parameters from T-Mobile (class 60) and Vodafone (class 61).

Length of the class 6* data sets: 327 bytes each

Factory configuration:

The factory configuration of **class 60 (C60)** and **class 61 (C61)** is shown in **bold**.

Both parameter classes include a range that is reserved for possible expansions. Parameter expansions that are covered by these reserved ranges do not lead to any incompatibility between different firmware versions. If the expansion space is not sufficient, a new parameter class must be created. This likewise does not lead to any incompatibility, because a command to set/read this new parameter class from an older firmware will be acknowledged with ERROR. The reserved parameter ranges are filled in with '0' (0x30) during communication.

Class 6x/Parameters	Offset	Len	Values (ASCII)	Description
String length of provider name	0	2	'00' .. '32'	C60: '20' C61: '20'
Provider name	2	32	Max. 32 characters ('0' .. '9', 'a' .. 'z', 'A' .. 'Z')	C60: 'T-Mobile Germany' C61: 'Vodafone Germany'
String length of GSM Net ID	34	1	'1' .. '9'	C60: '5' C61: '5'
GSM Net ID	35	9	Max. 9 characters '0' .. '9'	C60: '26201' for T-Mobile C61: '26202' for Vodafone
String length of PDP_CONTEXT	44	3	'000' .. '128'	C60: '039' C61: '038'
PDP_CONTEXT	47	128	20h .. 7Eh	C60: '1,"IP","internet.t-d1.de", "0.0.0.0",0,0' C61: '1,"IP","web.vodafone.de", "0.0.0.0",0,0'
String length of APN user name	175	2	'00' .. '32'	C60: '04' C61: '04'
APN user name	177	32	Max. 32 characters ('0' .. '9', 'a' .. 'z', 'A' .. 'Z')	C60: 'guest' C61: 'guest'
String length of APN password	209	2	'00' .. '32'	C60: '04' C61: '04'

Class 6x/Parameters	Offset	Len	Values (ASCII)	Description
APN password	211	32	Max. 32 characters (‘0’ .. ‘9’, ‘a’ .. ‘z’, ‘A’ .. ‘Z’)	C60: ‘ guest ’ C61: ‘ guest ’
String length of dial-in string	243	2	‘00’ .. ‘32’	C60: ‘ 08 ’ C61: ‘ 08 ’
Dial-in string	245	32	Max. 32 characters (‘0’ .. ‘9’, ‘a’ .. ‘z’, ‘A’ .. ‘Z’)	C60: ‘ *99***1# ’ C61: ‘ *99***1# ’
DNS1	277	15	‘0’ .. ‘9’ and ‘.’	C60: ‘ 193.254.160.001 ’ C61: ‘ 139.007.030.125 ’
DNS2	292	15	‘0’ .. ‘9’ and ‘.’	C60: ‘ 194.025.002.131 ’ C61: ‘ 139.007.030.126 ’
Reserve for parameter expansions	307	20	TBD	TBD

7.4 GPRS-/IP-Server mode

Attention

A precondition for use of the GPRS/IP server functionality of the ZDUE-GSM-PLUS-V is that the GPRS mode is activated in class 82.

The GPRS mode is deactivated by default!

GPRS data communication

The ZDUE-GSM-PLUS-V can be operated as an IP server. In this GPRS mode a client (e.g. a control centre) establishes a bidirectional data connection via the GPRS (**G**eneral **P**acket **R**adio **S**ervice) of a GSM network (**G**lobal **S**ystem for **M**obile **C**ommunication).

TCP/IP data communication for machines that are not TCP/IP-capable themselves.

The communication via TCP/IP protocol that is necessary for this is provided by the ZDUE-GSM-PLUS-V. It transmits data from electricity meters as well as meters for other media which can be connected to the ZDUE-GPRS-PLUS-V's interfaces and that are not TCP/IP capable themselves.

The ZDUE-GSM-PLUS-V in GPRS mode functions largely in the same way as the CSD mode described above. Special features are described in the following sections.

GPRS/IP server mode

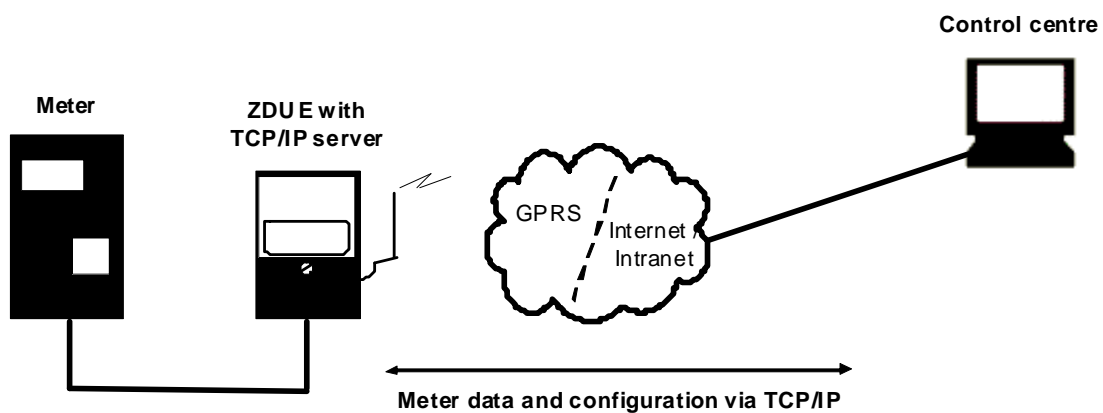

Attention

In order to establish in GPRS mode an IP connection to the ZDUE-GSM-PLUS-V from a client, the IP address of the ZDUE-GSM-PLUS-V must be known to the client. For this reason it is advisable to use a SIM card with an assigned fixed IP address.

Dialling into the GPRS network

The connection to the GPRS provider is established automatically after the device is restarted, so long as the GPRS mode is activated in class 82.

To successfully establish the connection, the GPRS access data must be configured in the parameter classes 60 and 61:

- Provider (selection of the GPRS network operator, e.g. T-D1, Vodafone)
- PDP_Context (access parameters of the GPRS network operator)
- USER (login name in the GPRS network)
- PASSWORD (login password in the GPRS network)
- Dial-in string (not used)
- DNS1 (primary Domain Name Server in the GPRS network; optional)
- DNS2 (secondary Domain Name Server in the GPRS network; optional)

In addition, the timing behaviour in the event of problems with the GPRS dial-in can be set via class 82.

Attention

Please note that data packets are exchanged even when a connection is (re-) established, when an attempt to connect to a remote station is made (e.g. server is switched off, wrong destination address, etc.), and to maintain a connection. Please especially note this when using networks which are subject to charges!

Setting up the IP server

Like dialling-in to the GPRS network, the IP server is set up automatically when GPRS mode is activated. The following characteristics of the IP server must be defined in class 82:

- GPRS function (must be set in order for the device to work in GPRS mode)
- Server port 1 (port at which the server waits for incoming IP connection requests; server port 2 is not considered)

Optionally the access authorisation can be limited in class 82:

- Check source IP address of the client (the source IP address of a connection request is evaluated)
- Source IP addresses 1 to 5 (valid source addresses of a connection request)
- Check source port of the client (the source port of a connection request is evaluated)
- Source ports 1 to 5 (valid source ports of a connection request)

GSM data communication

As a substitute (e.g. in case of failure of the GPRS connection) the ZDUE-GSM-PLUS-V in GPRS mode can accept also CSD calls (CircuitSwitchedData calls) from a remote station, thus providing communication via the GSM network.

In this case the behaviour for data transmission to any other desired modem in the GSM or fixed network is the same as described above.

**Changeover
between GPRS and
GSM operation**

Manual changeover between GPRS operation and GSM operation is not necessary. GSM data calls (CSD) are accepted if

- GPRS mode is deactivated, but the device is checked into the GSM network
- the device is logged into the GPRS network
- the IP server is set up, but there is no active IP connection

CSD calls are rejected if

- a CSD connection already exists
- an active IP connection has been established (independent of the data flow)

In order to accept the GSM data call the GPRS connection is terminated. When the GSM data call is complete, the GSM data call is restarted, the GPRS connection is re-established and the IP server is set up again

**Remote
configuration via
GSM data
connection**

Remote configuration of the ZDUE-GSM-PLUS-V in GPRS mode is possible via GPRS as well as via GSM connection.

Attention

For time-critical applications there can be limitations for GPRS transmissions.

Although the transmission in the GPRS network generally only lasts a few 100s of milliseconds, due to the packet-switched infrastructure of the GPRS network individual data packets may take quite a bit longer to arrive, i.e. up to several seconds.

This can also lead to problems when time-critical control centre software is used if it expects replies within a certain time after commands are sent out.

7.4.1 Access protection

The ZDUE-GSM-PLUS-V in GPRS mode accepts exactly one active IP connection at a time. If there is already an active IP connection to the ZDUE-GSM-PLUS-V, further connection requests are rejected by the device.

Furthermore, the ZDUE-GSM-PLUS-V offers the possibility of regulating the group of authorised clients. Two different mechanisms can be activated independently of each other for this purpose:

Source IP check

In parameter class 82, up to five IP addresses can be stored for the source IP check. Only IP connection requests that have one of these IP addresses as the source address will be accepted. If no match is determined for the address, the ZDUE-GSM-PLUS-V rejects the connection request.

Precondition: The source IP check in parameter class 82 must be activated; by default no IP check is performed.

Source port check

In parameter class 82, up to five port numbers can be stored for the source port check. Only IP connection requests that have one of these port numbers as the source port number will be accepted. If no match is determined for the port, the ZDUE-GSM-PLUS-V rejects the connection request.

Precondition: The source port check in parameter class 82 must be activated; by default no port check is performed.

7.4.2 Function indicators

In the GPRS mode, the function indicators behave the same as in the CSD mode; A existing TCP/IP connection is not indicated.

7.4.3 Parameters

The following table provides an overview of the parameter classes contained in the ZDUE-GSM-PLUS-V additionally for GPRS mode. These classes are assigned to numbers, which must also be specified in parameterisation commands.

	Class	Permitted access types (R=Read/W=Write)
Provider classes	60, 61	R/W
GPRS operating parameters	82	R/W

Parameters can only be written by writing a complete class (i.e. an offset and length must also be specified with '0000').

When a class is expanded the new parameters must be appended in order to ensure downward compatibility.

Parameter class 82

Length of the class 82 data set: 208 bytes

Factory configuration: The factory configuration of **class 82** is shown in **bold**.

This class describes the GPRS parameters of the ZDUE-GSM-PLUS-V. The class is defined as an open class, i.e. data sets that are longer than what is defined here are accepted. The non-specified values are ignored in evaluation by the device. When the parameters are read only the specified values are output.

Class 82/Parameters	Offset	Len	Values (ASCII)	Description
GPRS function is active	0	1	'0' or '1'	'0': GPRS function is switched off '1': GPRS function is switched on Def.: '0'
Server port 1 at which the device receives data	1	5	5 characters '0' .. '9'	Port number at which the server 'listens' Def.: '26864'
Server port 2 at which the device receives data	6	5	5 characters '0' .. '9'	Port number at which the server 'listens' Def.: '00000' ⁴
Check source IP of the communication	11	1	'0' or '1'	'0': IP checking is switched off '1': IP checking is switched on Def.: '0'
Check source port of the communication	12	1	'0' or '1'	'0': Port checking is switched off '1': Port checking is switched on Def.: '0'
Source IP no. 1 for permitted access	13	15	'0' .. '9' and '.'	Source IP of a potential communication partner Def.: '000.000.000.000' ⁵
Source port no. 1 for permitted access	28	5	5 characters '0' .. '9'	Source port of a potential communication partner Def.: '00000' ⁶
Source IP no. 2 for permitted access	33	15	'0' .. '9' and '.'	Source IP of a potential communication partner Def.: '000.000.000.000'
Source port no. 2 for permitted access	48	5	5 characters '0' .. '9'	Source port of a potential communication partner Def.: '00000'

⁴ If a '00000' is defined for the server port, the server function is not activated. The second port number is not supported at present. It should be classified as a reserve.

⁵ If checking of the source IP is activated, the source IP of the external communication partner must match completely.

⁶ If checking of the source port is activated, the source port of the external communication partner must match completely.

Class 82/Parameters	Offset	Len	Values (ASCII)	Description
Source IP no. 3 for permitted access	53	15	'0' .. '9' and '.'	Source IP of a potential communication partner Def.: '000.000.000.000'
Source port no. 3 for permitted access	68	5	5 characters '0' .. '9'	Source port of a potential communication partner Def.: '00000'
Source IP no. 4 for permitted access	73	15	'0' .. '9' and '.'	Source IP of a potential communication partner Def.: '000.000.000.000'
Source port no. 4 for permitted access	88	5	5 characters '0' .. '9'	Source port of a potential communication partner Def.: '00000'
Source IP no. 5 for permitted access	93	15	'0' .. '9' and '.'	Source IP of a potential communication partner Def.: '000.000.000.000'
Source port no. 5 for permitted access	108	5	5 characters '0' .. '9'	Source port of a potential communication partner Def.: '00000'
Connection test via ping activated	113	1	'0' or '1'	'0': Ping function is switched off '1': Ping function is switched on ⁷ Def.: '0'
Time interval for ping test in minutes	114	4	'0000' to '9999'	A cyclical ping is performed on one or more URLs in the specified cycle. Def.: '0030'
IP address 1 for ping test	118	15	'0' .. '9' and '.'	Destination IP of a potential communication partner for a ping ⁸ e.g.: '062.109.255.003' Def.: '000.000.000.000'
IP address 2 for ping test	133	15	'0' .. '9' and '.'	Destination IP of a potential communication partner for a ping e.g.: '062.109.255.003' Def.: '000.000.000.000'
IP address 3 for ping test	148	15	'0' .. '9' and '.'	Destination IP of a potential communication partner for a ping e.g.: '062.109.255.003' Def.: '000.000.000.000'
IP address 4 for ping test	163	15	'0' .. '9' and '.'	Destination IP of a potential communication partner for a ping e.g.: '062.109.255.003' Def.: '000.000.000.000'

⁷ No ping monitoring function is implemented at present

⁸ No ping monitoring function is implemented at present

Class 82/Parameters	Offset	Len	Values (ASCII)	Description
IP address 5 for ping test	178	15	'0' .. '9' and '.'	Destination IP of a potential communication partner for a ping e.g.: '062.109.255.003' Def.: '000.000.000.000'
Connection timeout for a failed GPRS login attempt	193	3	'000' .. '999'	Time in seconds after which a GPRS login is repeated after a failed attempt. Def.: '300'
Number of dialling attempts to GPRS service before module reset	196	1	'0' .. '9'	Number of attempts to login to the GPRS service before the module is reset. Def.: '3'
Server timeout until disconnect	197	3	'000' .. '300'	Time in seconds after which the module automatically terminates the TCP server service. '000': Module remains logged into the service continuously Def.: '000'
Waiting time after x failed GPRS login attempts	200	3	'001' .. '999'	Time in minutes that have to go by after a login error (incl. repetitions) before the GPRS module tries to log in again. Def.: '060'
Ping port (TCP sync)	203	5	5 characters '0' .. '9'	Port on which the "IP ping" (TCP sync) is performed. '00000'..'65535'. Def.: '00080'
	208			

7.4.4 Register data set in GPRS mode

General

The register data set in GPRS mode is the same as in CSD mode. When GPRS mode is activated, the IP address currently assigned to the device is output in register 129-72:23.7.0 (see also Section 6.4)

<i>Example:</i>	Accounting data of ZDUE-GSM-PLUS-V
1-1:F.F(00000005)	Error status
1-1:0.0.0(12345678)	Power supply company identification
1-1:0.2.0(4.016)	Firmware version of the ZDUE
1-1:0.9.1(135224)	Time (hhmmss)
1-1:0.9.2(110326)	Date (yymmdd)
1-1:C.91.0(Revision 01.002)	Firmware version of GSM module
129-72:23.7.0(29.9.18.87)	[own IP address]
!	
T	

Format of the error status

The error status format is described in Section 6.4.2.

7.4.5 Communication commands according to DIN EN 62056-21

The ZDUE-GSM-PLUS-V in GPRS mode supports the same communication commands as in CSD mode. There are also GPRS-specific commands; these are listed in the following.

Parameterisation commands

The three parameter classes 60, 61 and 82 additionally contained in the ZDUE-GSM-PLUS-V for GPRS mode are configured according to the parameterisation of the ZDUE-GSM-PLUS-V standard classes (see 6.5.3) and saved to non-volatile memory in the device using the parameter transfer command (see 6.5.4).

Service commands

R3 commands:

1. Reading GPRS operating parameters:

Command format: <SOH>**R3**<STX>**S96(12)**<ETX><BCC>

Reply format: <STX>S96(12)(LocalIP)(NetMask)(Gateway)(DNS1)(DNS2) <ETX><BCC>

The parameters have the following meaning here:

LocalIP	IP address currently assigned to the device. If the device currently has no address assigned to it, "000.000.000.000" is output.
NetMask	This value remains empty
Gateway	This value remains empty
DNS1	Current DNS1
DNS2	Current DNS2

Example (reply): <STX>S96(12)(172.20.233.0)()(139.007.030.125)(139.007.030.126)<ETX><BCC>

This command is also permitted via the GSM interface.

When GPRS mode is deactivated this command is unknown and will be rejected with an error message:

Reply in case of error: <ETX>(ERROR01)<ETX><BCC>

8 Technical data

Power supply:

Input voltage (Un)	100 VAC bis 230 VAC +/-10%, 50/60Hz 60 VDC bis 100 VDC +/-10% (protected against polarity reversal)
Input current (In)	40 mA @ 230 VAC 120 mA @ 60 VDC
Typical power consumption	3,2 W; attached to radio network, incidental data transmission

GSM interface:

Frequency bands	Quad-Band: GSM-850 MHz (2W), GSM-900 MHz (2W) and GSM-1800 MHz (1W), PCS-1900 MHz (1W) optional
Circuit Switched Data (CSD)	9.6 kbps V.110, RLP, non-transparent Connection to other GSM data terminals, to analogue modems (V.32) and to ISDN data terminals.
General Packet Radio Service (GPRS)	Multislot Class 10 Fully PBCCH support Mobile Station Class B Coding Scheme 1 – 4
SIM card	ID-000 format (25 mm x 15 mm); 3V
Antenna connector	SMA, approx. 50 Ohm

Meter interfaces:

CL1	Current loop (20mA) according DIN EN 62056-21, Mode A/C, up to 19,2 kbit/s
RS-232	Full duplex Signals: Rx, Tx, DSR, GND Data rate: max. 38.400 Baud (max. cable length < 3 m) Cable length: max. 15 m
RS-485	Signals: RT+, RT- Transceiver: max. 32 Data rate max. 19.200 Baud Cable length: max. 1000 m
Configuration	DIN EN 62056-21
Meter communication	Meter mode: DIN EN 62056-21: Mode C, Mode A (equates to transparent) AT mode: GSM data modem function with AT command interface

Galvanic insulation:

Test voltage	Power supply terminals L1, N against all interfaces: 3 kVAC, 50 Hz, 1 min. Between interfaces: 500 VAC, 50 Hz, 1min.
--------------	---

Environmental conditions:

Temperature	Operation: - 20°C ... +55°C; +55°C ... +65°C (derating) Storage: - 20°C ... +85°C
Humidity	0 - 95 % relative, non condensing

Housing:

Design	Standard housing for terminal cover mounting, three-point mounting according to DIN 43857-7
Material	Plastic, flammability according to UL94-V0
Protection class	IP 51
Dimensions	H=180 mm, W=105 mm, D=70 mm
Weight	approx. 350 g

Inspections/Approvals:

CE mark	Yes
Air interface (R&TTE)	GCF-compatible GSM module
	EN 301 511: v.9.0.2 GSM 900 and GSM 1800 bands: Essential requirements of article 3.2 of the R&TTE directive
Immunity to interference (EMC directive)	EN 55024 (1998) + A1 (2001)+ A2 (2003) Immunity characteristics
	EN 61000-6-2 (2005) Immunity for industrial environment
	EN 61000-4-2 (2009) Electrostatic discharge immunity
	EN 61000-4-3 (2006) +A1 (2008) Electromagnetic field immunity
	EN 61000-4-4 (2004) Electrical fast transient/burst immunity
	EN 61000-4-5 (2006) Surge immunity
	EN 61000-4-6 (2009) Conducted disturbances, induced by radio-frequency fields
	EN 61000-4-11 (2004) Voltage dips, short interruptions and voltage variations
Emitted interference (EMC directive)	EN 55022 (2006) + A1 (2007) Limit B Radio disturbance characteristics
	EN 61000-6-3 (2007) Emission standard for residential, commercial and light-industrial environment
Electrical safety (Low voltage directive)	EN 60950 (2006) Information technology equipment Protection class 2, Overvoltage category III