

# ZDUE-LTE-PLUS-VII

## User manual



## Copyright Statement

The articles published in this publication are protected by copyright. Translations, reprints, reproduction and storage in data processing systems require the express permission of Sagemcom Dr. Neuhaus GmbH.

© 2021 by Sagemcom Dr. Neuhaus GmbH

All rights reserved

Sagemcom Dr. Neuhaus GmbH

Papenreye 65, D-22453 Hamburg

Phone: +49 (40) 55304-0

Fax.: +49 (40) 55304-180

Internet: [www.sagemcom.com/neuhaus](http://www.sagemcom.com/neuhaus)

Subject to technical changes.

All trademarks and product names are trademarks, registered trademarks or product names of their respective owners.

All deliveries and services are provided by Sagemcom Dr. Neuhaus GmbH based on the General Terms and Conditions of Sagemcom Dr. Neuhaus GmbH in the current version. All information is based on manufacturer's data. No warranty or liability for incorrect and omitted entries. The contents of this manual and the technical specifications are subject to change without notice. The descriptions of the specifications in this manual do not constitute a contract.

Product no. DNT8230

Doc. no. 8230AD011, version 1.1 / February 2021

As of firmware version 8.014 (ZDUE-LTE-PLUS-VII)

---

## Classification of the safety instructions

This manual contains information that you must observe for your personal safety and to avoid damage to property. The instructions for your personal safety are highlighted by a warning triangle, instructions for property damage alone are without a warning triangle. Depending on the hazard level, the warnings are shown in decreasing order as follows.



---

### **Danger**

means that death or serious bodily injury **will** occur if the appropriate precautions are not taken.

---



---

### **Warning**

means that death or serious bodily injury **may** occur if the appropriate precautions are not taken.

---



---

### **Caution**

with warning triangle means that minor personal injury may occur if the appropriate precautions are not taken.

---

---

### **Caution**

without a warning triangle means that property damage may occur if the appropriate precautions are not taken.

---

---

### **Attention**

means that an undesirable result or condition may occur if the corresponding note is not observed.

---

If several hazard levels occur, the warning for the highest level is always used. If the warning triangle is used in a warning against personal injury, a warning against damage to property may also be added to the same warning.

## General

The ZDUE-LTE-PLUS-VII complies with the European standard EN 62368-1, Equipment for audio/video, information, and communication technology - Part 1: Safety requirements.

The ZDUE-LTE-PLUS-VII is not suitable for connection to IT systems of the electrical power supply.

Before using the device, carefully read the following safety instructions, the commissioning instructions in this manual and the installation instructions.

## Qualified personnel staff

The associated device/system may only be set up and operated in conjunction with this documentation. Commissioning and operation of a device/system may only be carried out by **qualified personnel**. Qualified personnel in the sense of the safety instructions in this documentation are persons who are authorised to commission, earth and label devices, systems and circuits in accordance with the standards of safety technology.

## Intended use

Note the following:



---

### Warning

The device may only be used for the applications specified in the data sheets and in this document. Faultless and safe operation of the product requires proper transport, storage, installation and assembly as well as careful operation and maintenance.

---

## Disconnection from the supply circuit



---

### Warning

In the house installation, an easily accessible, all-pole disconnecting device is required in the supply circuit. Alternatively, a 1-pole disconnecting device can be used in the outer conductor of the supply circuit if a distinctive neutral conductor is introduced in the supply line. Country-specific regulations must be observed. In Germany, the disconnecting device must at least meet the requirements of the DIN VDE standard of the 0100 series (cf. CENELEC HD384; IEC 60364).

---

---

## Installation fuse



---

### Warning

An installation fuse in accordance with DIN VDE series 0100 (cf. CENELEC HD384; IEC 60364) must be provided in the house installation, which is adapted to the cable cross-section of the power supply line. The additional short-circuit protection must have a disconnecting capacity of  $I > 1500A$ .

---

## Transient overvoltages



---

### Warning

The ZDUE-LTE-PLUS-VII is a device of overvoltage category III. If the ZDUE-LTE-PLUS-VII likely to be exposed to higher transient overvoltages than those of overvoltage category III when connected, additional protective measures are required in the installation.

---

## Radio



---

### Warning

Never use the device in areas where the operation of radio equipment is prohibited. The device contains a radio transmitter that may interfere with the operation of medical electronic devices such as hearing aids or pacemakers. Your doctor or the manufacturer of such devices can advise you.

To prevent data media from being demagnetised, do not store floppy disks, credit cards or other magnetic data media near the device.

---

## Antenna mounting



---

### Warning

The antenna of the ZDUE-LTE-PLUS-VII may only be installed and operated at a minimum distance of 20 cm from people.

The antenna must be installed and operated in such a way that it does not interact with other antennas or equipment.

When using a directional antenna, observe the legal limit for electromagnetic fields (0 Hz to 300 GHz) in public spaces. For details see recommendations of the EU Council 1999/519/EC of 12 July 1999.

---

---

### Attention

When laying the antenna cable, pay attention to the bending radii. Failure to observe the bending radii of the antenna cable will result in a deterioration of the transmission and reception characteristics of the device. The minimum bending radius must not be less than 5 times the cable diameter statically and 15 times the cable diameter dynamically.

---

## Mounting an outdoor antenna



---

### Caution

Installation outdoors must be carried out by a qualified person. The standards DIN EN 60728-11 VDE 0855-1 and DIN VDE 0855-300 as well as other national installation guidelines for lightning protection must be followed.

---

## Connection costs

---

### Caution

Please note that data packets are also exchanged during the (re-) establishment of a connection, during connection attempts to the remote terminal (e.g. server switched off, wrong destination address, etc.) as well as to maintain a connection, which may be subject to charges depending on the mobile phone contract.

---

## Table of contents

<b>1</b>	<b>How it works</b> .....	<b>9</b>
1.1	Intended use.....	9
1.2	Topologies.....	9
1.3	Meter mode (IP server and IP telemetry mode).....	10
1.4	AT mode.....	11
1.5	Connection of meters.....	11
1.6	Access protection.....	11
1.7	Timer and module reset.....	12
1.8	Configuration (parameterisation) and firmware update.....	12
<b>2</b>	<b>Operating elements, connections and function displays</b> .....	<b>13</b>
2.1	Overview.....	13
2.2	Service button.....	13
2.3	DIP switch.....	13
2.4	Function indicators ( LEDs).....	14
2.5	Connections on the terminal block, RJ45 socket.....	15
<b>3</b>	<b>Commissioning</b> .....	<b>16</b>
3.1	Inserting the SIM card.....	16
3.2	Connect meter.....	17
3.3	Connecting the ZDUE-LTE-PLUS-VII to the supply voltage.....	17
3.4	Attach and connect the antenna.....	18
3.5	Configure the device if required.....	19
3.6	Setting and Unlocking the SIM PIN.....	19
<b>4</b>	<b>Interfaces</b> .....	<b>20</b>
4.1	The mobile radio interface.....	20
4.2	Meter interfaces.....	20
4.3	Interface types.....	21
4.4	Auxiliary voltage source.....	23
<b>5</b>	<b>Operation in AT mode</b> .....	<b>24</b>
<b>6</b>	<b>Operation in meter mode</b> .....	<b>25</b>
6.1	Communication according to EN 62056-21.....	25
6.2	Establishing a connection to the mobile network.....	26
6.3	IP server mode.....	29
6.3.1	Parameter.....	30
6.3.2	Access protection.....	30
6.4	IP telemetry mode.....	31
6.4.1	Parameter.....	32
<b>7</b>	<b>Configuration</b> .....	<b>33</b>
7.1	Parameter.....	33
7.2	Writing and reading the parameters.....	34
7.3	Parameter classes.....	35
7.3.1	Representation.....	35
7.3.2	Class 79 - General operating parameters.....	36
7.3.3	Classes 60/61 - Access parameters LTE/GPRS.....	38
7.3.4	Class 82 - Parameter IP server.....	40
7.3.5	Class 70 - IP Telemetry Client (1st IPT Master).....	43
7.3.6	Class 76 - P-Telemetry Client (2nd IPT Master).....	45
7.3.7	Class 78 - Delay parameters.....	46
<b>8</b>	<b>Register data set of the ZDUE-LTE-PLUS-VII</b> .....	<b>47</b>
<b>9</b>	<b>Communication commands according to EN 62056-21</b> .....	<b>49</b>
9.1	Error messages.....	49
9.2	Set password.....	50
9.3	Parameterisation commands.....	50
9.3.1	Write class (complete).....	51
9.3.2	Class reading in sub-blocks.....	52
9.3.3	Parameter transfer command.....	52
9.3.4	Time / date commands.....	53

9.4	Operating status word .....	53
9.4.1	Read status word .....	55
9.4.2	Reset status word.....	55
9.5	Service commands .....	55
9.5.1	Parameter reset to factory configuration .....	55
9.5.2	Remote reset.....	55
9.5.3	Write PIN .....	56
9.5.4	Read out parameter checksum .....	56
9.5.5	Read out the firmware version of the ZDUE .....	56
9.5.6	Read the firmware version of the radio module .....	56
9.5.7	Read version of the booter .....	56
9.5.8	Read out the position of the DIP switches/parameter status .....	57
9.5.9	Read mobile radio operating/module parameters .....	57
9.5.10	Read out unique serial number: .....	57
9.5.11	Read LTE/GPRS operating parameters.....	58
<b>10</b>	<b>Maintenance/troubleshooting.....</b>	<b>59</b>
10.1	Maintenance .....	59
10.2	Troubleshooting.....	59
<b>11</b>	<b>Transport, storage and disposal .....</b>	<b>60</b>
11.1	Transport .....	60
11.2	Storage .....	60
11.3	Disposal .....	60
<b>12</b>	<b>Technical data .....</b>	<b>61</b>



# 1 How it works

## 1.1 Intended use

The ZDUE-LTE-PLUS-VII is a **meter data transmission device**. It is used for remote query and remote monitoring of electricity meters as well as meters for other media.

Data transmission for remote retrieval and remote monitoring takes place via an IP connection of a mobile network (LTE, GSM/GPRS or UMTS).

### Attention

The ZDUE-LTE-PLUS-VII is not suitable for communication via GSM dial-up connections (CSD = Circuit Switched Data).

## 1.2 Topologies

The ZDUE-LTE-PLUS-VII uses the IP data service of a mobile network (LTE, GSM/GPRS, UMTS) for data transmission for remote enquiry and remote monitoring.

The ZDUE-LTE-PLUS-VII offers a choice of two communication modes ...

### ... IP server mode

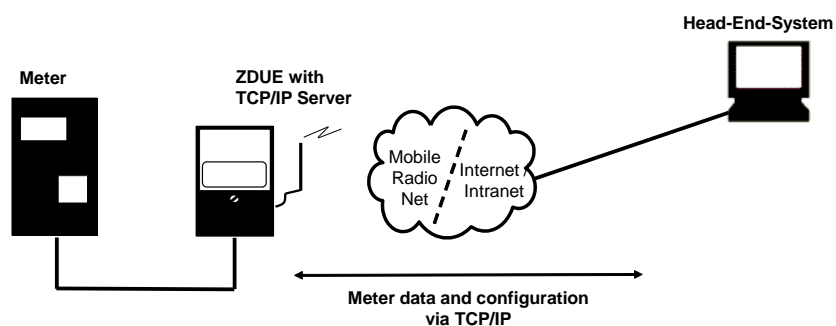

### ... IP telemetry Mode (IPT)

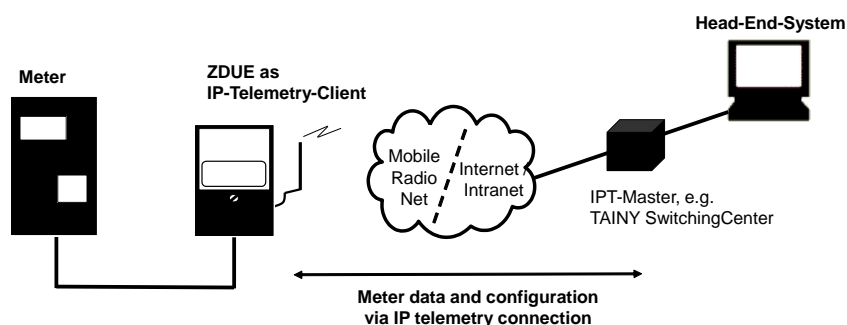

### 1.3 Meter mode (IP server and IP telemetry mode)

---

In meter mode, the ZDUE-LTE-PLUS-VII connects independently to the mobile network after a restart and establishes operational readiness. For this purpose, the ZDUE-LTE-PLUS-VII must be parameterised beforehand.

Communication with the head end system is either via a TCP/IP connection with the ZDUE-LTE-PLUS-VII as the server or via an IP telemetry connection.

#### Transparent communication

In IP server mode and in IP telemetry mode, the ZDUE-LTE-PLUS-VII receives data from the head end system and forwards them to the connected meters without changing their content.

In the opposite direction, the ZDUE-LTE-PLUS-VII data from the connected meters and sends this data to the head end system without changing its content.

#### Control / parameterisation per EN 62056-21

If the ZDUE-LTE-PLUS-VII recognises parameterisation commands in the format according to EN 62056-21 in the data coming from the head end system which are addressed to the ZDUE-LTE-PLUS-VII itself, these commands will not be forwarded to the connected meters but answered by the ZDUE-LTE-PLUS-VII.

#### IP server mode

The integrated mobile radio module of the ZDUE-LTE-PLUS-VII establishes an IP data connection to the mobile radio network after a restart.

##### IP server mode

- In IP server mode, the ZDUE-LTE-PLUS-VII automatically sets up an IP server.
- The head end system can then establish a TCP/IP connection to this server.
- Telegrams can be exchanged between the head end system and the meter or the ZDUE-LTE-PLUS-VII via this TCP/IP connection.

#### IP telemetry mode

##### IP telemetry mode

- In IP telemetry mode, the ZDUE-LTE-PLUS-VII connects to an IPT master via an IP telemetry connection.
- The head end system that is also connected to the IPT master can then connect to the ZDUE-LTE-PLUS-VII via an IPT-CS connection.
- Telegrams can be exchanged between the head end system and the meter or the ZDUE-LTE-PLUS-VII via this IP telemetry connection.

The ZDUE-LTE-PLUS-VII reacts to the telegrams transmitted by the head end system as follows:

- It connects to the meters connected to its interfaces (CL1, RS-232, RS-485).
- It accepts and executes parameterisation commands.

## 1.4 AT mode

The AT mode allows and requires the direct control of the mobile radio module integrated in the ZDUE-LTE-PLUS-VII by means of AT commands. The AT commands can be entered via a meter interface.

All other functions (e.g. IP server mode, IP telemetry mode, control / parameterisation per EN 62056-21 etc.) are not available in AT mode.

## 1.5 Connection of meters

The ZDUE-LTE-PLUS-VII following interfaces for connecting meters: CL1, RS232 and RS485. The maximum permissible number of meters can be connected to each interface at the same time.

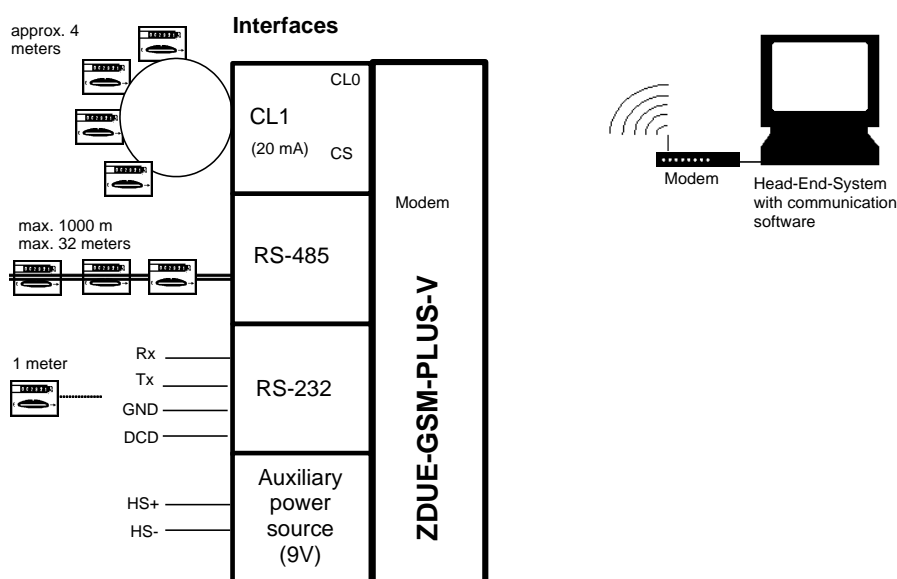

In addition, the device has an auxiliary voltage source (9V) for supplying meters.

All meters connected to the ZDUE-LTE-PLUS are simultaneously connected to the Head-End-System via a single connection. The Head-End-System addresses the connected meters directly and communicates with them. The ZDUE-LTE-PLUS-VII only passes the data in both directions and, if necessary, adjusts the bit rate and character format.

## 1.6 Access protection

### ... by password

To protect against unauthorised access, a password query can be configured. In this case, the ZDUE-LTE-PLUS-VII requests the agreed password from the remote terminal, which must be given to it within the configured time period (password timeout). If the password is incorrect or the timeout is exceeded, the ZDUE-LTE-PLUS-VII will disconnect from the remote terminal. The password can be parameterised.

## 1.7 Timer and module reset

---

The ZDUE-LTE-PLUS-VII does not have a real-time clock, but a timer is kept based on and with the accuracy of the processor quartz.

This timer controls the automatic module reset function, which can be activated and configured in parameter class 79.

The automatic reset cycle starts when the device is switched on, i.e. the first module reset takes place after the parameterised period has elapsed from the start of the device. Further module resets then follow at intervals defined by the parameterised period.

The time for the daily watchdog, which is also to be configured in parameter class 79, is not used by the ZDUE-LTE-PLUS-VII.

## 1.8 Configuration (parameterisation) and firmware update

---

### Configuration via software

The configuration is done via configuration software (e.g. the **ZDUEParametrierTool**). With the help of this software, parameterisation commands are transmitted to the ZDUE-LTE-PLUS-VII.

The parameterisation commands can be transmitted to the ZDUE-LTE-PLUS-VII via the mobile network (remote configuration) or are transmitted directly via the RS-232 interface (local configuration) with a PC connected there.

### Configuration via DIP switches

The operating mode of the ZDUE-LTE-PLUS-VII can be switched between meter mode and AT mode via the DIP switch inside the housing. See chapter 5 and chapter 6.

### Firmware update

A firmware update can be carried out via configuration software (e.g. the **ZDUEParametrierTool**) from a computer that is locally connected directly to the RS-232 interface of the ZDUE-LTE-PLUS-VII.

## 2 Operating elements, connections and function displays

### 2.1 Overview

To insert the SIM card and to change the operating mode via DIP switch, the device must be opened. The following diagram provides an overview of the internal components of the device that are important for the user:

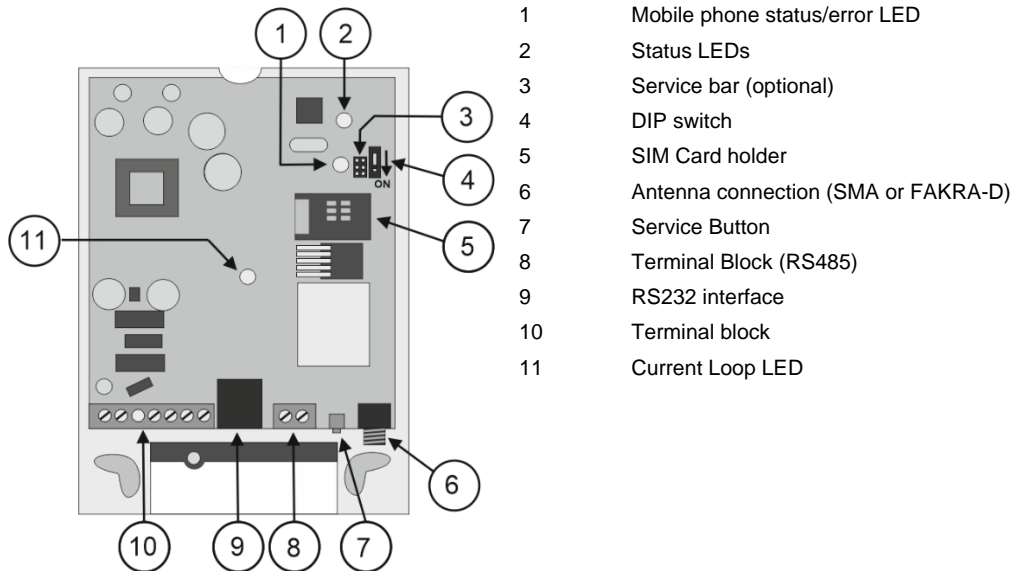

### 2.2 Service button

The service button can be used to reset all device parameters to factory settings as well as for a simplified readout of the firmware version. The service button is only effective in meter mode.

#### Reset to factory setting

Pressing and holding the service button once for more than five seconds **during operation** will delete the parameterisation set in the device via EN62056-21 commands. After releasing the button, the ZDUE-LTE-PLUS-VII restarts and adopts the default settings specified in the device software when booting.

#### Output of the firmware version during booting

If the service button is kept pressed **during switch-on**, the ZDUE-LTE-PLUS-VII the current firmware version of the device via the serial interface. The data format of the connected terminal program must be set to 19200 baud 8N1.

### 2.3 DIP switch

With the DIP switch it is possible to switch between meter mode and AT mode. See chapter 5 and chapter 6.

## 2.4 Function indicators (LEDs)

To check the operating status, the device is equipped with 3 LEDs. They are used to indicate the functions currently being performed and the respective status.

LED	Colour / Action	Meaning
<b>Power</b>	<ul style="list-style-type: none"> <li>• Green &amp; Orange under Light Dome</li> <li>Permanently green</li> <li>Green, flashing orange</li> <li>Orange, flashing green</li> <li>Green, flickering orange</li> </ul>	<ul style="list-style-type: none"> <li>Operating voltage is present</li> <li>Network searching</li> <li>Idle, logged in to the mobile radio network</li> <li>Data transfer is ongoing</li> </ul>

If the SIM card is missing or defective, the two LEDs go out after a short time.

LED	Colour / Action	Meaning
<b>Status/Error</b>	<ul style="list-style-type: none"> <li>• Orange</li> <li>3s on / 3 x short flashing</li> <li>3s on / 2 x short flashing</li> <li>3s on / 1 x brief flashing</li> <li>3s off / 1x short flashing</li> <li>3s off / 2x short flashing</li> <li>3s off / 3x short flashing</li> <li>3s off / 4x short flashing</li> <li>Permanently on</li> <li>Permanently on</li> </ul>	<ul style="list-style-type: none"> <li>Boot phase, network search</li> <li>Error condition</li> <li>SIM/PIN error</li> <li>Field strength low</li> <li>Field strength moderate</li> <li>Field strength good</li> <li>Field strength high</li> <li>LTE/GPRS connection active.</li> <li>Field strength unknown</li> </ul>

IP server mode: An existing TCP/IP connection is not displayed.

IP telemetry mode: An existing IP telemetry connection is not displayed.

AT mode: This LED is not effective (off) in AT mode.

LED	Colour / Action	Meaning
<b>Current Loop</b>	<ul style="list-style-type: none"> <li>• Green</li> <li>• From</li> </ul>	<ul style="list-style-type: none"> <li>CL meter(s) is/are connected, or CL interface is bridged</li> <li>Current loop is interrupted</li> </ul>

## 2.5 Connections on the terminal block, RJ45 socket

The connection of the ZDUE-LTE-PLUS-VII to the supply voltage as well as the connection of the meters to the ZDUE-LTE-PLUS-VII are made via the 9-pole terminal block (supply, auxiliary voltage, CL, RS-485) as well as an RJ45 socket (RS-232).

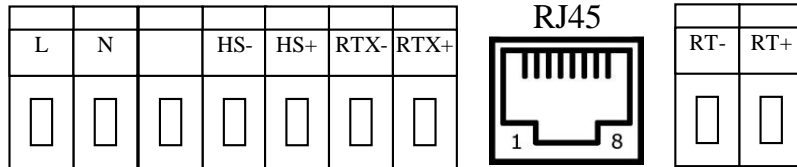

### Terminal block:

PIN no.	Signal	Function/Comment
1	L	Mains voltage connection
2	N	Mains voltage connection
3		Not documented
4	HS-	Auxiliary voltage -
5	HS+	Auxiliary voltage +
6	RTX-	Current Loop CL1 -
7	RTX+	Current Loop CL1 +
8	RT-	RS-485 RT-
9	RT+	RS-485 RT+

### RJ45:

2	DSR	Positive RS-232 voltage (output; always active)
4	GND	Signal GND / cable shield
5	TxD	RS-232 TxD (output)
6	RxD	RS-232 RxD (input)

### 3 Commissioning

To put the ZDUE-LTE-PLUS-VII operation, proceed as follows:

	Page
1. Read the safety instructions at the beginning of this document.	4
2. Insert SIM card	16
3. Configure the ZDUE-LTE-PLUS-VII if required	33
- Connect the ZDUE-LTE-PLUS-VII supply voltage	17
- Carry out the configuration	33
- Disconnect the ZDUE-LTE-PLUS-VII from the supply voltage again.	17
3. Connect meter	17
4. Attach and connect the antenna	18
5. Connect the ZDUE-LTE-PLUS-VII supply voltage	17

#### 3.1 Inserting the SIM card



#### Warning

Never insert or remove the SIM card during operation!

#### PIN

The factory setting of the ZDUE-LTE-PLUS-VII is such that SIM cards with PIN **0000** are accepted.

If the SIM card has a different PIN, you can adjust the setting of the ZDUE-LTE-PLUS-VII in parameter class 79 to the PIN of the SIM card (see Chapter 7.3.2). Alternatively, you can change the PIN of the SIM card with a mobile phone.

With some network operators it is also possible to switch off the PIN query of the SIM card. In this case, the PIN can be arbitrary, as it is not considered.

To insert the SIM card, proceed as follows:

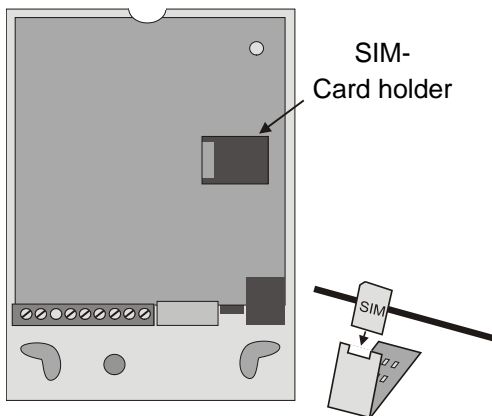

1. Disconnect the device from the supply voltage at all poles if it is connected there.
2. Loosen the screw of the clamp cover and remove the clamp cover.
3. Then remove the appliance lid.
4. Open the SIM card holder and slide the SIM card into the flap of the holder. The gold-plated contacts of the SIM card must be on the gold-plated contacts of the holder when the SIM card holder is closed.
5. Close the flap of the SIM card holder again and lock the flap by carefully sliding it to the left. You will feel it click into place.
6. Replace the device lid and the clamp lid.



### 3.2 Connect meter

The ZDUE-LTE-PLUS-VII has the meter interfaces listed below. Connect the meters to the terminal block according to the following illustrations. All interfaces can be used simultaneously.

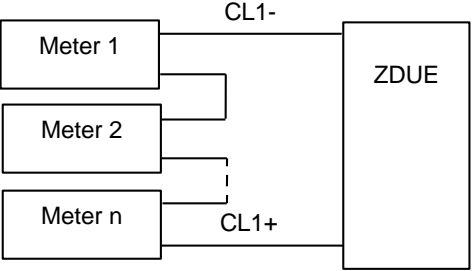
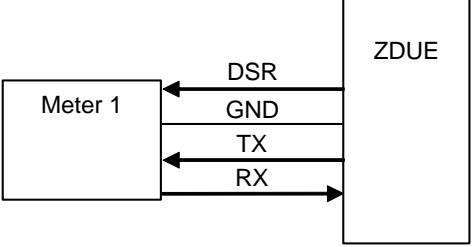
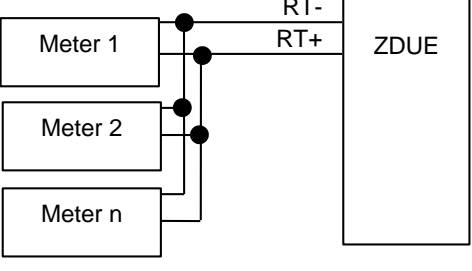
<p><b>CL1 interface</b></p> <p>This <b>20mA current interface</b> (current loop) is used to connect meters with current interface according to EN 62056-21.</p> <p>About 4 meters can be connected to this interface.</p> <p>Further information: →Page 21</p>	
<p><b>RS-232 interface</b></p> <p>It is used to connect a meter with an interface according to V.24/V.28.</p> <p>A maximum of 1 meter can be connected to this interface.</p> <p>Further information: →Page 22</p>	
<p><b>RS-485 interface (2-wire)</b></p> <p>It is used to connect meters with RS-485 interface.</p> <p>A maximum of 32 transceivers (meters) can be operated on the bus.</p> <p>The bus connection is terminated to <math>Z=120\ \Omega</math> (nominal) (RT+ to RT-) and the cable length is limited to 1000m.</p> <p>The interface is electrically isolated from the mains connection.</p> <p>Further information: →Page 21</p>	

### 3.3 Connecting the ZDUE-LTE-PLUS-VII to the supply voltage

The connection to the supply voltage is made via the terminals L and N of the terminal block. These terminals are designed for cables with a cross-section of up to 1.5 mm<sup>2</sup>.

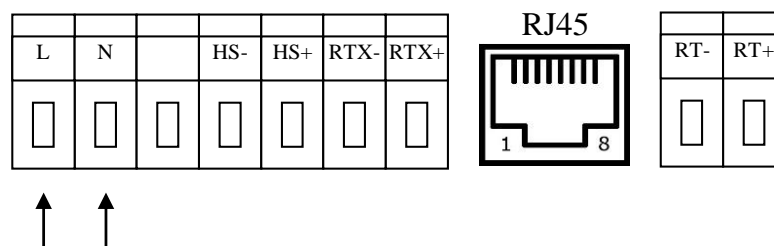

The ZDUE-LTE-PLUS-VII can be operated with both AC and DC voltages.

Supply voltage	Nominal values	Maximum values
AC voltage:	100VAC to 230VAC without changeover (50/60 Hz)	76VAC to 253VAC
DC voltage (reverse polarity protected):	60VDC to 100VDC without changeover	54VDC to 110VDC

The device complies with protection class 2. The supply of the interfaces is galvanically separated from the electronics.

### 3.4 Attach and connect the antenna

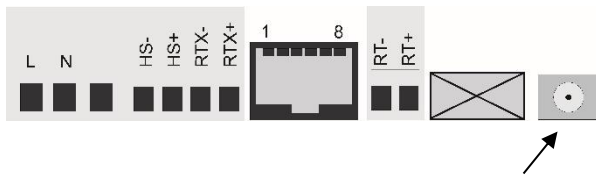

Antenna socket

Internal and external antennas of the ZDUE-LTE-PLUS-VII may only be installed and operated at a minimum distance of 20 cm from people.

The antennas must be installed and operated in such a way that they do not interact with other antennas or equipment.

When using a directional antenna, observe the legal limit for electromagnetic fields (0 Hz to 300 GHz) in public spaces. For details see recommendations of the EU Council 1999/519/EC of 12 July 1999.

Installation outdoors must be carried out by a qualified person. The standards EN 60728-11 and VDE 0855-300 as well as other national installation guidelines for lightning protection must be followed.

#### Antenna properties

Observe the instructions enclosed with your antenna. The antenna must have the following characteristics: Passive, gain < 2.3 dBi, VSWR < 2:1, impedance 50 Ω, matched for the frequency bands used. If the antenna does not meet these requirements, signal quality and matching will be adversely affected.

Use antennas from the ZDUE's range of accessories.

The antenna is connected to the antenna socket (ANT) of the SMA or FAKRA-D type. The antenna must be installed in such a way that a high field strength is achieved. Make sure that there are no large metal objects (e.g. reinforced concrete) in the vicinity of the antenna, as these adversely affect the signal quality.

### 3.5 Configure the device if required

<b>Basic setting On delivery</b>	<p>The ZDUE-LTE-PLUS-VII is delivered with a predefined factory setting. Depending on requirements, it must be reconfigured. This is</p> <ul style="list-style-type: none"> <li><input type="checkbox"/> <b>remotely</b> via an <b>LTE/GPRS connection</b></li> <li><input type="checkbox"/> <b>locally</b> via the <b>RS-232 interface</b> (if there is no active LTE/GPRS connection)</li> </ul> <p>possible.</p>
<b>Configuration options</b>	<p>Among other things, the password protection, interface speeds, data formats and the PIN to be used can be parameterised.</p> <p>For detailed information on parameterisation, see chapter 7.</p>

### 3.6 Setting and Unlocking the SIM PIN

<b>Parameterisation options</b>	<p>The PIN can be set as follows:</p> <ul style="list-style-type: none"> <li><input type="checkbox"/> <b>remotely</b> via an <b>LTE/GPRS connection</b></li> <li><input type="checkbox"/> <b>locally</b> via the <b>RS-232 interface</b> (if there is no active LTE/GPRS connection)</li> </ul>
<b>PIN-less SIM card</b>	<p>In the case of PIN-less SIM cards, the PIN query is bypassed, the radio module does not wait for the PIN to be entered but attempts to log into the mobile radio network immediately.</p>
<b>Behaviour with correct SIM PIN</b>	<p>If the PIN function of the SIM card used is activated and the PIN on the SIM card used matches the parameterised PIN, the device automatically attempts to log into the mobile radio network.</p>
<b>Behaviour in the event of an incorrect SIM PIN</b>	<p>If the PIN check fails, it is repeated once. If the repeated PIN check also fails, the device is blocked for further attempts (PIN-ERROR status), so that operation with a SIM card with the correct number is also no longer possible. The status/error LED signals a SIM/PIN error (see chapter 2.4).</p> <p>After disconnecting and reconnecting the power supply, this state is maintained. This prevents the SIM card from being blocked after a possible third failed attempt and can only be unlocked again by using the PUK (Personal Unblocking Key).</p>
<b>Unlocking the machine</b>	<p>To unlock the ZDUE-LTE-PLUS-VII, a SIM card with deactivated PIN function must be inserted into the device. After start-up, the device attempts to log into the mobile network, and the PIN-ERROR status is also reset.</p> <p>Alternatively, the ERROR status can be reset with the service command for setting a new PIN (see chapter 9.5). The PIN parameterised in the device is set at the same time.</p>

---

## 4 Interfaces

---

### 4.1 The mobile radio interface

---

**Properties** Communication with the mobile radio network takes place via an integrated radio module. The radio module supports the following mobile radio technologies: LTE (4G), UMTS (3G), GSM/GPRS (2G).

The data is transmitted using the TCP/IP protocol.

### 4.2 Meter interfaces

---

**Parameterisation** The parameterisation of the meter interfaces of the ZDUE-LTE-PLUS-VII is done for all of them together, i.e. all set interface parameters apply equally to all meter interfaces.

The following values are supported by the meter interfaces:

**Data format:** Default: 7E1

Adjustable: 7E1, 8N1, 8E1

**Handshake:** No hardware/software handshake.

**Interface speed:** Default: 300 baud (Mode C)

Adjustable: 300, 600, 1200, 2400, 4800, 9600, 19200, 38400, 57600 baud.

➡ However, the speed of the meter interfaces should not exceed 19200 bit/s, otherwise data loss may occur.

**Number of meters** Meters can be connected and operated simultaneously at all interfaces, but only up to the specified maximum number.

When communicating with the connected meters, all interfaces are addressed simultaneously, i.e. the application (e.g. head end system) cannot address any interface specifically. This makes it essential to address the meters unambiguously to prevent simultaneous transmission of data by several meters.

## Procedure for communication between head end system and meter

### Fixed baud rate:

The speed is set to a fixed value by setting parameters. The respective communicating meter and the head end system connected via the modem exchange the data directly at the selected speed, i.e. the ZDUE-LTE-PLUS-VII works transparently. The speed should be a maximum of 19200 bit/s or below.

### Variable baud rate:

Corresponds to baud rate switching according to mode C of EN 62056-21. The starting speed is e.g. 300 baud. The speed is increased if the communicating meter requests this from the corresponding interface and the interface confirms the desired baud rate. If no confirmation is received, communication continues at the current speed.

## 4.3 Interface types

### CL1 (Optional)

The CL1 interface corresponds to the current interface according to EN 62056-21.

This is an active 20mA interface with a 2-wire connection via terminals RTX- and RTX+ (terminals 6 and 7) of the terminal block.

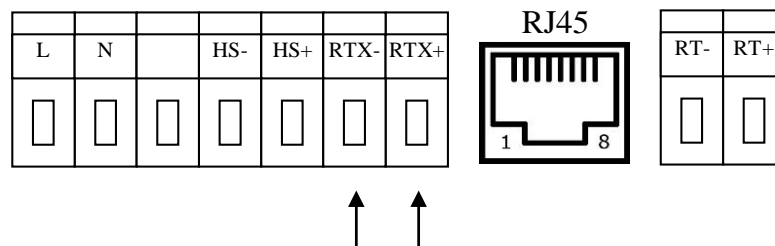

**Maximum connectable:** 4 meters

### Attention

If the CL interface is not used, it must be short-circuited with a wire jumper, otherwise the other interfaces of the ZDUE-LTE-PLUS-VII not function.

The interface is separated from the modem part via an optocoupler.

When reading a meter, all characters sent to the meter are sent back as an echo via the CL1 interface. These characters are normally transmitted to the higher-level system. The echo is suppressed by the device.

### RS-485

The meters are connected to the terminals RT- and RT+ (terminals 8, 9) of the terminal block via a 2-wire bus connection.

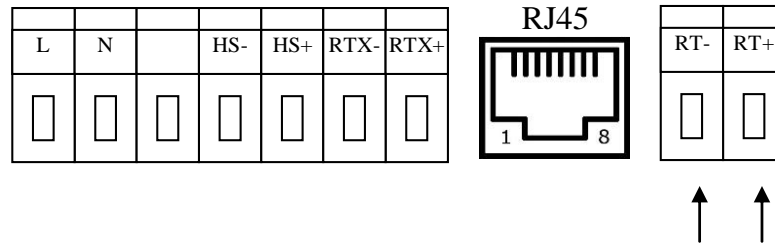

**Maximum connectable:** 32 meters

The bus connection is terminated to 120 Ohm (nominal) and the cable length is limited to 1000m.

The interface is electrically isolated from the mains connection.

### RS-232

The interface complies with the V.24 / V.28 specification.

A meter is connected to the RS-232 interface via the RJ45 socket next to the terminal block.

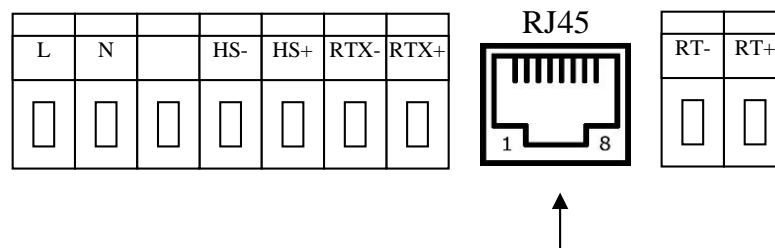

#### RJ45

Pin	Signal	Description
2	DSR	Output; always aktive
4	GND	Signal Ground
5	TXD	Output; data to the meter
6	RXD	Eingang; data from the meter
All other pins are reserved.		

**Maximum connectable:** 1 meter

An adapter cable (e.g. D-Sub9 DE-9 to RJ-45) may have to be used for connection.

The interface is electrically isolated from the mains connection.

#### Local configuration:

The ZDUE-LTE-PLUS-VII can be configured with a computer connected to this interface.

The setting for this is: 19200 baud, 8N1.

The RS-232 interface is automatically set to these values as soon as there is no LTE/GPRS connection.

#### 4.4 Auxiliary voltage source

##### Auxiliary voltage source (9V)

Some variants of the ZDUE-LTE-PLUS-VII have a 9V auxiliary voltage source. The connection is made via the terminals HS-, HS+ (terminals 4, 5).

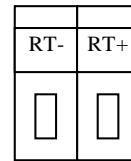
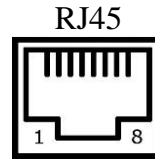
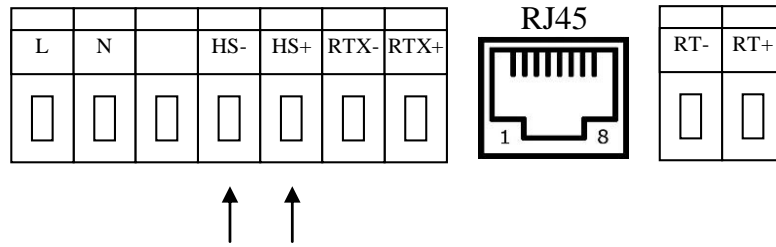

## 5 Operation in AT mode

---

When AT mode is activated, it is possible to address the radio module of the ZDUE-LTE-PLUS-VII directly via the serial interface by AT command. This allows the ZDUE-LTE-PLUS-VII used, for example, as a GSM terminal for establishing data connections via the mobile radio network.

To switch on the AT mode, disconnect the ZDUE-LTE-PLUS-VII from the power supply. Then set the DIP switch (see chapter 2.1) to "ON" so that the ZDUE-LTE-PLUS-VII operates in AT mode.

If the ZDUE-LTE-PLUS-VII is in the factory state, the serial interface is set as follows after switching to AT mode:

19200 bit/s, 8N1

To change the bit rate (e.g. from 19200 bit/s to 9600 bit/s), switch back to meter mode and change the **Start baud rate** parameter to the desired value. Then activate the AT mode again.

To set the bit rate back to the default value without parameterisation software, you can switch back to meter mode and perform a factory reset with the service button (see 2.2). Then activate the AT mode again.

---

### Attention

Please note that the service button will reset all settings of your ZDUE to the factory settings. If only the bit rate of the serial interface is to be changed, set the start baud rate in meter mode to 19200 bit/s as described above.

---

The character format cannot be changed, in AT mode 8N1 is always used.

Remote configuration is not possible.

To activate automatic call acceptance, enter the AT command ATSO=1.

---

### Attention

Please note that the hardware handshake (RTS/CTS) must be deactivated in the terminal software used for configuration (e.g. PuTTY).

---

---

### Attention

Never use AT commands that are used to switch the baud rate or data format on radio modules.

---



---

## 6 Operation in meter mode

---

To switch on the meter mode, disconnect the ZDUE-LTE-PLUS-VII from the power supply. Then set the DIP switch (see chapter 2.1) to "OFF" so that the ZDUE-LTE-PLUS-VII operates in meter mode.

In meter mode, the ZDUE-LTE-PLUS-VII automatically accepts IP or IP telemetry connections via the LTE/GPRS interface from the head end system and connects the connected meters directly to the head end system. In transparent mode (mode A according to EN 62056-21), the data speed on the meter interface is set to a fixed value by setting parameters. The respective communicating meter and the head end system connected via the modem exchange the data directly at the selected speed, i.e. the ZDUE-LTE-PLUS-VII data between head end system and meter. If Mode C according to EN 62056-21 is activated, the ZDUE-LTE-PLUS-VII adjusts the bit rate but does not change the data contents.

The ZDUE-LTE-PLUS-VII can be configured remotely via the LTE/GPRS connection using configuration commands in accordance with EN 62056-21.

---

### 6.1 Communication according to EN 62056-21

---

#### Control features

In meter mode, the ZDUE-LTE-PLUS-VII controls the communication between the head end system and the meters connected to the ZDUE-LTE-PLUS-VII in accordance with protocol EN 62056-21 (Appendix A):

- in mode A/C,
- in data readout and programming mode
- including data backup (reception) and acknowledgement.

The start baud rate and the data format can be set for the interfaces CL1 (Current-Loop Interface), RS-232 and RS-485.

Please note that these meter interface settings apply equally to all interfaces.

- In Mode C operation, the baud rate is switched according to the baud rate ID contained in the acknowledge telegram from the head end system.

#### Detection of the end of a communication cycle

During data readout, the end of a communication cycle is detected when

- $\geq 3$  seconds no meter data is received (Mode A/C Timeout)→
- the sequence 'CR LF ETX' is detected (Mode C regular end)→

In programming mode, the end of a communication cycle is detected when

- a 'Break' telegram is detected (Mode A/C abort)→.

After completion of a communication cycle, the connection is disconnected and the baud rate of the serial interface driver of the meter interfaces is reset to the parameterised start value.

### **Regular disconnection**

#### **Connection termination after transfer timeout:**

The ZDUE-LTE-PLUS-VII terminates a regular data connection after the transfer timeout has expired. This means: If there is no data transfer between the head end system and the ZDUE-LTE-PLUS-VII or the meters connected to the ZDUE-LTE-PLUS-VII within the specified timeout (default: 99 seconds), the ZDUE-LTE-PLUS-VII will terminate the connection.

#### **Disconnection by the head end system:**

For its part, the head end system can terminate a connection at any time.

---

## **6.2 Establishing a connection to the mobile network**

---

### **Dialling into the mobile network**

The connection to the mobile network is established automatically after the device is restarted.

For a successful connection setup, the LTE/GPRS access data must be configured in parameter classes 60 and 61:

- Provider (selection of the LTE/GPRS network provider, e.g. T-D1, Vodafone)
- PDP Context (access parameters of the LTE/GPRS network operator)
- USER (Login name for the LTE/GPRS network)
- PASSWORD (Login password for the LTE/GPRS network)
- Dial-in string (Not used)
- DNS1 (Primary Domain Name Server of the LTE/GPRS network; optional)
- DNS2 (Secondary Domain Name Server of the LTE/GPRS network; optional)

In addition, the timing behaviour in the event of problems with LTE/GPRS dial-up can be set via class 82.

---

#### **Caution**

Please note that data packets are also exchanged during the (re-)establishment of a connection, during connection attempts to the remote terminal (e.g. server switched off, wrong destination address, etc.) as well as to maintain a connection. Please take this into account especially when using chargeable networks.

---

#### **Attention**

To be able to operate the ZDUE-LTE-PLUS-VII, a SIM card activated for LTE/GPRS must be used. If necessary, contact your mobile phone provider.

---

Disturbances in the mobile network or with the mobile network provider can, for example, cause the ZDUE-LTE-PLUS-VII attempts to log in and dial in to fail. To prevent the device from continuously trying to connect to the mobile network (and possibly incurring costs in the process), the ZDUE-LTE-PLUS-VII has two timers and a counter that can be used to control the behaviour in such cases of interference.

For the IP server mode, these parameters are contained in parameter class 82 (see 7.3.4). For the IP telemetry module, these parameters are found in parameter class 70 and 78 (see chapter 7.3.5 and 7.3.7).

The ZDUE-LTE-PLUS-VII proceeds in two stages. If a login attempt fails, a number of login attempts defined by the *counter* is repeated at a certain interval (*Timer 1*) before the device performs a module reset after *Timer 2* has expired and restarts the login process.

### Connection establishment in IP server mode

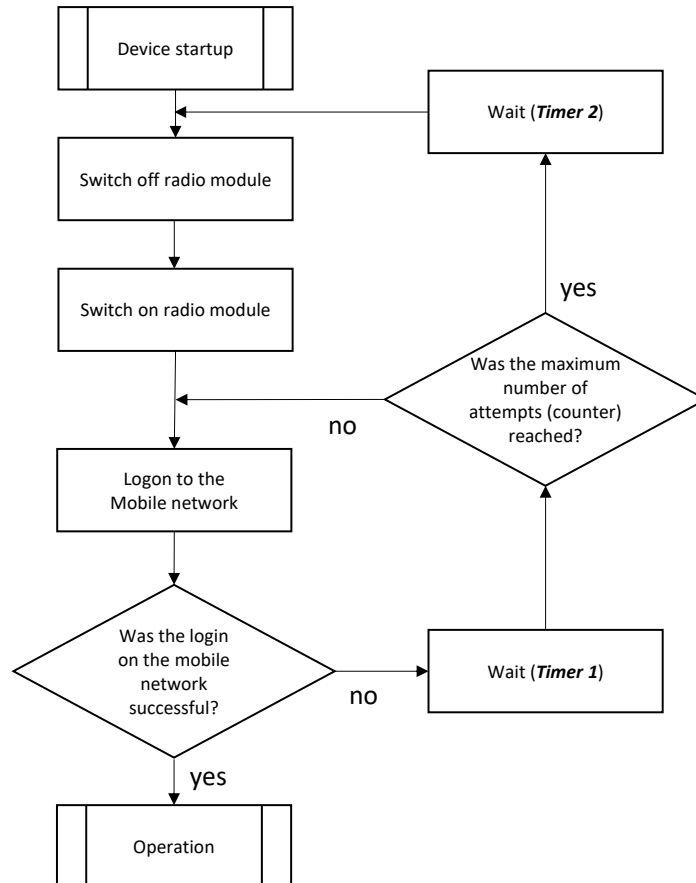

*Counter*: Class 82 – Number of login attempts

*Timer 1*: Class 82 – Connection timeout on failed mobile network login attempt

*Timer 2*: Class 82 – Waiting time after x failed attempts Mobile network login

### Connection establishment in IP telemetry mode

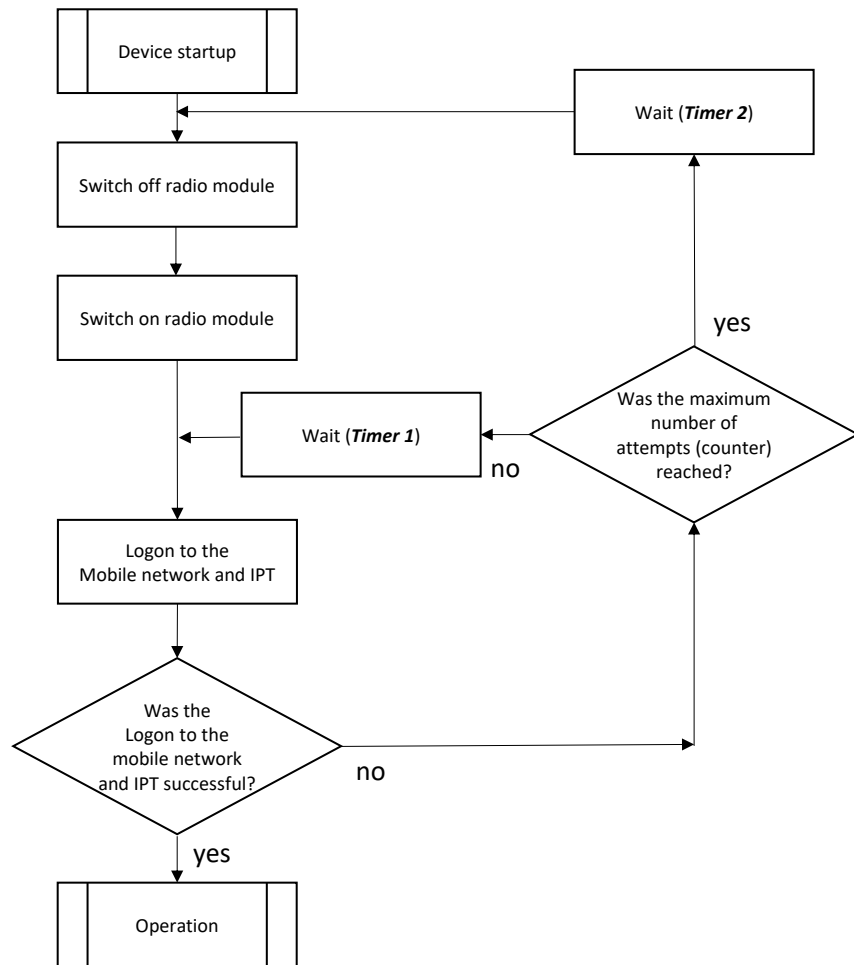

*Counter*: Class 70 – Number of login attempts

*Timer 1*: 15s constantly

*Timer 2*: Class 78 – Delay times between connection attempts

### 6.3 IP server mode

#### ZDUE-LTE-PLUS-VII: GPRS data communication

The ZDUE-LTE-PLUS-VII can be operated as an IP server. In this mode, a client (e.g. a head end system) establishes a bidirectional TCP/IP data connection via the LTE/GPRS mobile radio network.

#### TCP/IP data communication for machines that are not TCP/IP-capable - themselves.

The communication required for this by means of TCP/IP protocol is provided by the ZDUE-LTE-PLUS-VII. It transmits data from both electricity meters and meters for other media that can be connected to the ZDUE-LTE-PLUS-VII via the interfaces mentioned above and are not TCP/IP-capable themselves.

#### IP server mode

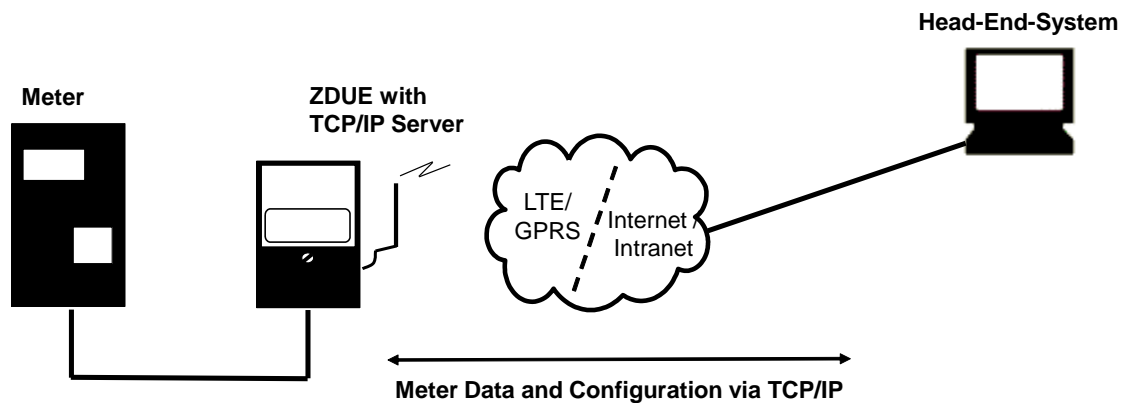

#### Attention

In order to be able to establish an IP connection to the ZDUE-LTE-PLUS-VII a client, the client must know the IP address of the ZDUE-LTE-PLUS-VII. Therefore, a SIM card is required that has been assigned a fixed IP address by the network operator.

#### Attention

For time-critical applications, there may be limitations with LTE/GPRS transmissions.

Although the transmission in the mobile radio network usually takes only a few 100 milliseconds, due to the packet-switching infrastructure of the LTE/GPRS networks, individual data packets can take longer, i.e. up to several seconds.

This can also lead to problems when using time-critical head end system software if it expects responses within a certain time after sending out commands.

### 6.3.1 Parameter

The following table provides an overview of the parameter classes for IP server operation in addition to those contained in the ZDUE-LTE-PLUS-VII. These classes are assigned numbers which must be specified in parameterisation commands.

#### Parameter

	Class	Permitted access types (R=Read/W=Write)
Provider classes	60, 61	R/W
GPRS operating parameters	82	R/W

Parameters can only be written by writing a complete class (i.e. offset and length must be specified with '0000' in the parameterisation command).

#### Activation

In order for the ZDUE-LTE-PLUS-VII to work in IP server mode, the parameter "String length IP destination address / host name" in parameter class 70 must be set to "00".

When parameterising with parameterisation software that sets the string length automatically (such as the **ZDUEParametriertool**), this is achieved by completely deleting the IP address of the primary IPT master.

#### Setting up the IP server

The IP server is set up automatically in the same way as dialling into the mobile radio network when LTE/GPRS mode is activated. The following properties of the IP server must be set in class 82:

- LTE/GPRS function (must be set for the device to work in LTE/GPRS mode)
- Server port 1 (port on which the server waits for incoming IP connection requests, server port 2 is not taken into account)
- Optionally, the access authorisation can be restricted in class 82:
- Check source IP address of the client (the source IP address of a connection request is evaluated)
- Source IP addresses 1 to 5 (valid source addresses of a connection request)
- Check source port of the client (the source port of a connection request is evaluated)
- Source port 1 to 5 (valid source ports of a connection request)

### 6.3.2 Access protection

The ZDUE-LTE-PLUS-VII accepts exactly one active IP connection at a time in IP server mode. If there is already an active IP connection to the ZDUE-LTE-PLUS-VII, further connection requests will be rejected by the device.

In addition, the ZDUE-LTE-PLUS-VII in IP server mode offers the possibility to regulate the group of authorised clients. For this purpose, two different mechanisms can be activated independently of each other:

**Source IP control** In parameter class 82, up to five IP addresses can be stored for source IP control. Only IP connection requests that have one of these IP addresses as the source address will be accepted. If no address match is detected, the ZDUE-LTE-PLUS-VII connection request.

Prerequisite: The source IP check in parameter class 82 must be activated; by default, no IP check takes place.

**Source port control** In parameter class 82, up to five port numbers can be stored for source port control. Only IP connection requests that have one of these ports as the source port number will be accepted. If no port match is detected, the ZDUE-LTE-PLUS-VII connection request.

Prerequisite: The source port check in parameter class 82 must be activated; by default, no port check takes place.

## 6.4 IP telemetry mode

In the IP telemetry operating mode, as soon as the connection to the Internet or Intranet via LTE/GPRS is established, the ZDUE-LTE-PLUS-VII establishes an IP telemetry connection to the parameterised IP telemetry master according to DIN 43863-4. For this purpose, access for the device must be set up at the IP telemetry master (e.g. Dr. Neuhaus TAINY SwitchingCenter V3). The login is done by means of password and gate name.

### IP telemetry mode

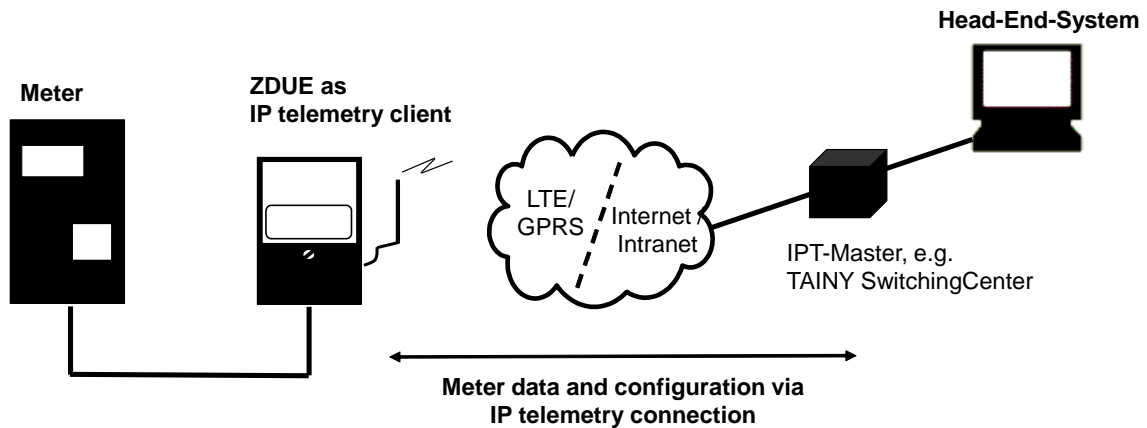

In the event that the connection to the IP telemetry master is disturbed or the master refuses the connection (e.g. due to non-availability or faulty login), a secondary master can be parameterised in the ZDUE-LTE-PLUS-VII which the ZDUE-LTE-PLUS-VII alternatively attempts to log in.

If the function "Load Balancing" is activated for the TAINY SwitchingCenter used as the primary or secondary TAINY SwitchingCenter, a registration can be rejected for reasons of load distribution. In this case, the ZDUE-LTE-PLUS-VII is given an IP address by the IP telemetry master to which the device should register instead. This address is independent of the parameterisation in the ZDUE-LTE-PLUS-VII.

### 6.4.1 Parameter

The following table gives an overview of the additional parameter classes for the IP telemetry mode. These classes are assigned numbers that must be included in parameterisation commands.

#### Parameter

	<b>Class</b>	<b>Permitted access types (R=Read/W=Write)</b>
Provider classes	60, 61	R/W
IP Telemetry Client Parameters	70, 76, 78	R/W

Writing parameters can only be done by writing a complete class.

#### Activation

In order for the ZDUE-LTE-PLUS-VII to operate in IP telemetry mode, the parameter "String length IP destination address / host name" in parameter class 70 must **not** be set to "00".

When parameterising with parameterisation software that sets the string length automatically (such as the **ZDUEParametrierTool**), this is achieved by writing the IP address of the Primary IPT Master into the ZDUE.



---

## 7 Configuration

---

### 7.1 Parameter

---

In meter mode, the ZDUE-LTE-PLUS-VII works independently of an external control, i.e. it independently establishes operational readiness and the connection to the head end system after applying the supply voltage.

For this, it is necessary that function and communication parameters are configured beforehand.

The configuration is done via configurable parameters, which are grouped in several parameter classes.

**Overview parameter class** Before the ZDUE-LTE-PLUS-VII can be used, it must be parameterised. This is done via the following parameter class:

#### **Class 79 - General operating parameters**

Parameter class for configuring identifiers (IDs) of the ZDUE, passwords for the EN 62056-21 protocol, basic settings for the meter and mobile radio interface and the automatic periodic reset (watchdog).

#### **Classes 60/61 - Mains parameters**

Parameter class for configuring the access data to the mobile network, e.g. APN, username, password, etc.

#### **Class 82 - IP server parameters**

Parameter class for configuring the IP server mode, e.g. IP address, port, access protection.

---

#### **Attention:**

In order for the ZDUE-LTE-PLUS-VII to work in IP server mode, the parameter "String length IP destination address / host name" in parameter class 70 must be set to "00".

When parameterising with parameterisation software that sets the string length automatically (such as the **ZDUEParametrierTool**), this is achieved by completely deleting the IP address of the primary IPT master.

---

#### **Classes 70/76 - IPT parameters**

Parameter classes to configure the IP telemetry mode, e.g. addresses and port of the IPT master, login names, etc.

---

#### **Attention:**

In order for the ZDUE-LTE-PLUS-VII to work in IP telemetry mode, the parameter "String length IP destination address / host name" in parameter class 70 must **not** be set to "00".

When parameterising with a parameterisation software that sets the string length automatically (such as the **ZDUEParametrierTool**), this is achieved by writing the IP address of the primary IPT master into the ZDUE

---

### **Class 78 - Delay parameters**

Parameter class with settings for the time behaviour when establishing a connection to the mobile network.

### **Class 54 - Switching time parameter (Without function)**

This class is only implemented for compatibility reasons. Basically, it specifies the changeover times of a real-time clock from summertime to normal time or from normal time to summertime. However, since the ZDUE-LTE-PLUS-VII does not have a real-time clock, parameter class 54 has no significance for the operation of the ZDUE-LTE-PLUS-VII. The parameters of this class cannot be changed.

**Writing parameters** Parameters can only be written by writing a complete class (i.e. offset and length must be specified with '0000' in the parameterisation command).

---

## **7.2 Writing and reading the parameters**

---

Parameters are written and read using the parameterisation commands described in chapter 9.3

The parameterisation commands can be transmitted to the ZDUE-LTE-PLUS-VII via the mobile radio network (remote configuration) or directly via the RS-232 interface (local configuration).

**Remote configuration via the mobile radio network** The remote configuration is carried out by the head end system. This sends parameterisation commands to the ZDUE-LTE-PLUS-VII via the mobile radio network. The transmission is carried out in accordance with EN 62056-21 with BCC secured protocol.

The parameterisation commands must be sent explicitly to the address of the ZDUE-LTE-PLUS-VII.

The factory default setting of the device address is: **99999999**

The device address is configurable. It can contain up to 16 digits, numbers and letters are permissible.

**Local Configuration** The device can also be configured with the help of a computer that is directly connected to the RS-232 interface of the ZDUE-LTE-PLUS-VII via its COM port.

**Precondition:** There is no LTE/GPRS connection between the ZDUE-LTE-PLUS-VII and any head end system.

### **Mobile phone offline state: Settings of the RS-232 interface**

As soon as there is no LTE/GPRS connection, the RS-232 interface is set to the following setting by default:

19200 bit/s  
8 data bits, no parity, 1 stop bit

Make sure that the settings of the COM port used on the connected configuration computer match and switch off any flow control (hardware (RTS/CTS), XON-XOFF).

If the computer connected to the RS-232 interface sends request telegrams with the device address of the ZDUE-LTE-PLUS-VII (default: **99999999**), the ZDUE-LTE-PLUS-VII will react in the same way as if it received the request telegrams via the mobile radio network from the remote head end system.

During local configuration via the RS-232 interface, the ZDUE-LTE-PLUS-VII not accept calls from the mobile radio network.

**Mobile phone online state: Settings of the RS-232 interface**

As soon as an LTE/GPRS connection is established, the RS-232 interface switches to the set bit rate and data format in meter mode. The default setting is:

300 bit/s, 7E1, Mode C

- ☞ The settings of the RS-232 interface for the mobile radio -online state are configurable.

**Attention**

Please note that the RS-232 interface can only be used if the current loop is closed (by at least one connected meter or a wire jumper between the two current loop terminals RTX- and RTX+). In this case, the current loop LED must light up (see chapter 2.4).

## 7.3 Parameter classes

### 7.3.1 Representation

In the following, the parameters are sorted by class and shown in the same way as their notation in parameterisation commands. The **factory configuration** is highlighted in **bold**. The indications *Offset*, *Len* and *Values (ASCII)* have the following meanings:

<b>Offset</b>	Contains the relative address of a parameter within the parameter class, related to the class structure.
<b>Len</b>	Returns the number of ASCII characters required to represent the parameter during communication. For strings, only the number of ASCII characters specified with 'String length' is significant (decimal-coded), the string range that may not be used must be filled.
<b>Values (ASCII)</b>	Contains permissible values (ranges) for the individual parameters when writing (W1 command) and reading by means of R3 commands.

### 7.3.2 Class 79 - General operating parameters

This class describes the general operating parameters of the ZDUE-LTE-PLUS-VII. It is defined as an open class, i.e. longer data sets than defined here are accepted. The non-specified values are ignored in the evaluation by the device. When reading out the parameters, only the specified values are output.

Length of the class 79 record: 124 bytes

#### Factory configuration:

The factory configuration (**def.**) of **class 79** is shown in **bold**.

Class 79 Parameter	Offset	Len	Values (ASCII)	Description
String length EVU identification	0	2	'01' .. '16'	Def.: <b>'08'</b>
EVU identification	2	16	' ' .. '~', (0x20..0x7E)	EVU identification of the ZDUE-LTE-PLUS-VII in the register data set Def.: <b>'00000000'</b>
String length Device address (IEC address)	18	2	'01' .. '16'	Def.: <b>'08'</b>
Device address ZDUE-LTE-PLUS-VII	20	16	('0' .. '9', 'a' .. 'z', 'A' .. 'Z')	Def.: <b>'99999999'</b>
String length Set password	36	2	'00' .. '16'	Def.: <b>'08'</b>
Set password	38	16	' ' .. '~' (20h .. 7Eh) without '(', ')'	Def.: <b>'00000000'</b>
Head end system password active	54	1	'0' '1'	No password protection Password without recall
String length head end system password	55	2	'00' .. '16'	Length of the head end system password Def.: <b>'03'</b>
Head end system password	57	16	' ' .. '~' (20h .. 7Eh)	Def.: <b>PW0</b>
String length Communication ID	73	2	'01' .. '16'	Def.: <b>'15'</b>
Communication ID	75	16	' ' .. '~' (20h .. 7Eh)	Def.: <b>'1KGL923390R0003'</b>
Data format for the meter interface	91	1	'0' '1' '2'	7 data bits, even parity, 1 stop bit 8 data bits, no parity, 1 stop bit 8 data bits, even parity, 1 stop bit
Mode C monitoring	92	1	'0' '1'	Meter switching external meters according to IEC61107 to mode C is monitored Purely transparent data operation with fixed baud rate according to start baud rate.
Transfer timeout [seconds]	93	2	'10' to '99'	10 to 99 seconds Def.: <b>'99'</b>

Class 79 Parameter	Offset	Len	Values (ASCII)	Description
Call acceptance delay	95	2	'01' .. '15'	is ignored ( <b>always '01'</b> )
Start baud rate	97	1	'0' '1' '2' '3' '4' '5' '6' '7' '8'	300 baud 600 baud 1200 baud 2400 baud 4800 baud 9600 baud 19200 baud 38400 baud 57600 baud (optional)
Bearer Service	98	2	'00' '07' '08' '09' '10'	Autobauding, without function 9600bps (V.32), without function 14400bps (V.34), without function 9600bps (V.110), without function 14400bps (V.110), without function
Data backup/compression	100	1	'0' '1'	RLP, without function non RLP, without function
Country code	101	2	'00'	Reserve, not in use
Daily watchdog	103	1	'0' '1'	activated, the device falls on the watchdog No daily watchdog active
Time for daily watchdog	104	4	'2100'	The watchdog interval starts at this time every day, relative to the device time.
Interval for watchdog	108	1	'0' '1' '2' '3' '4' '5'	every 24 hours Watchdog every 12 hours Watchdog every 6 hours Watchdog every 3 hours Watchdog every 2 hours every 1 hour Watchdog
Data format to the head end system <sup>1</sup>	109	1	'0' '1'	Data format 7E1 (simulated)  Data format 8N1
String length PIN	110	1	'4' .. '8'	Def.: '4
PIN <sup>2</sup>	111	9	('0' .. '9')	Def.: '0000

<sup>1</sup> The ZDUE-LTE-PLUS-VII evaluates all characters in the receive path in data format 7N. This applies to Mode C monitoring and addressing and communication with the ZDUE-LTE-PLUS-VII (address "99999999"). The set data format is used in the transmission path to the head end system (independent of the application interface). This function has the consequence that it is irrelevant for the parameterisation of the ZDUE-LTE-PLUS-VII which data format is set at the head end system or in the modem.

<sup>2</sup> If the device is in the "error-free PIN" status, the PIN is changed accordingly both in the device and on the SIM. The change is carried out in service mode immediately after the take-over command for parameters. The new PIN is only saved in the device parameters after the PIN has been changed correctly on the SIM.

Class 79 Parameter	Offset	Len	Values (ASCII)	Description
Operator Set Mode	120	1	'0' '1' '4'	Automatic: Roaming allowed Manual: Roaming not allowed! Manual / Automatic: Roaming is permitted, but the radio module may be stopped cyclically (operator set delay) to log into the home network (GSM Net ID = first 5 digits of the IMSI).
Operator Delay Set	121	2	'15' .. '99'	Interval for module request 'operator select' if parameterised and actual operator are different.
Cyclical polling of the call diversion	123	1	'0' '1'	Call forwarding query is active Call forwarding query is passive

### 7.3.3 Classes 60/61 - Access parameters LTE/GPRS

The provider-specific LTE/GPRS access parameters for two different network providers can be stored in parameter classes 60 and 61. Based on the IMSI of the inserted SIM card, the firmware automatically recognises the GSM Net ID (first 5 digits of the IMSI) of the responsible provider and searches for this GSM Net ID in parameter classes 60 and 61. If it finds it, the parameters contained in the corresponding class are used.

In the factory configuration, the two classes are assigned the LTE/GPRS access parameters of T-Mobile (class 60) and Vodafone (class 61).

Length of class 6\* records: 327 bytes each

#### Factory configuration:

The factory configuration (**def.**) of **class 60 (C60)** and **class 61 (C61)** is shown in **bold**.

Both parameter classes include a reserved range for possible extensions. Parameter extensions covered by these reserve areas do not lead to incompatibility between different firmware states. If the extension space is not sufficient, a new parameter class must be created. This also does not lead to incompatibility because a command to set/read this new parameter class would be acknowledged with ERROR by an older firmware. The reserved parameter areas are filled with '0' (0x30) during communication.

Class 6x/Parameter	Offset	Len	Values (ASCII)	Description
String length Provider name	0	2	'00' .. '32'	C60: '20' C61: '20'
Provider name	2	32	Max. 32 characters ( '0' .. '9', 'a' .. 'z', 'A' .. 'Z' )	C60: 'T-Mobile Germany' C61: 'Vodafone Germany'
String length GSM Net ID	34	1	'1' .. '9'	C60: '5' C61: '5'
GSM Net ID	35	9	Max. 9 characters '0' ... '9'	C60: '26201' for T-Mobile C61: '26202' for Vodafone
String length PDP_CONTEXT	44	3	'000' .. '128'	C60: '039' C61: '038'
PDP_CONTEXT	47	128	20h .. 7Eh	C60: '1, "IP", "internet.t-d1.de", "0.0.0.0",0,0' C61: '1, "IP", "web.vodafone.de", "0.0.0.0",0,0'
String length APN username	175	2	'00' .. '32'	C60: '04' C61: '04'
APN username	177	32	Max. 32 characters ( '0' .. '9', 'a' .. 'z', 'A' .. 'Z' )	C60: 'gast' C61: 'gast'
String length APN password	209	2	'00' .. '32'	C60: '04' C61: '04'
APN password	211	32	Max. 32 characters ( '0' .. '9', 'a' .. 'z', 'A' .. 'Z' )	C60: 'gast' C61: 'gast'
String length dial-in string	243	2	'00' .. '32'	C60: '08' C61: '08'
Dial-up string	245	32	Max. 32 characters ( '0' .. '9', 'a' .. 'z', 'A' .. 'Z' )	C60: '*99***1#' C61: '*99***1#'
DNS1	277	15	'0' .. '9' and '.'	C60: '193.254.160.001' C61: '139.007.030.125'
DNS2	292	15	'0' .. '9' and '.'	C60: '194.025.002.131' C61: '139.007.030.126'
<b>Reserve f. parameter extensions</b>	307	20	TBD	TBD

### 7.3.4 Class 82 - Parameter IP server

Length of the class 82 data set: 208 bytes

#### Factory configuration:

The factory configuration (**def.**) of **class 82** is shown in **bold**.

This class describes the LTE/GPRS parameters of the ZDUE-LTE-PLUS-VII. The class is defined as an open class, i.e. longer data sets than described here are accepted. The unspecified values are ignored in the evaluation by the device. When reading out the parameters, only the specified values are output.

Class 82/Parameter	Offset	Len	Values (ASCII)	Description
LTE/GPRS function is active	0	1	'0' or '1'	'1': LTE/GPRS function is switched on Other values are ignored.
Server port 1 on which the device receives data	1	5	5 characters '0' ... '9'	Port number on which the server 'listens' Def.: <b>'26864'</b>
Server port 2 on which the device receives data	6	5	5 characters '0' ... '9'	Port number on which the server 'listens' Def.: <b>'00000'</b> <sup>3</sup>
Check source IP of communication	11	1	'0' or '1'	'0': IP check is switched off '1': IP check is switched on Def.: <b>'0'</b>
Check source port of communication	12	1	'0' or '1'	'0': Port check is switched off '1': Port check is switched on Def.: <b>'0'</b>
Source IP No. 1 for permitted access	13	15	'0' .. '9' and '.'	Source IP of a potential communication partner Def.: <b>'000.000.000.000'</b> <sup>4</sup>
Source port no. 1 for permitted access	28	5	5 characters '0' ... '9'	Source port of a potential communication partner Def.: <b>'00000'</b> <sup>5</sup>
Source IP no. 2 for permitted access	33	15	'0' .. '9' and '.'	Source IP of a potential communication partner Def.: <b>'000.000.000.000'</b>
Source port no. 2 for permitted access	48	5	5 characters '0' ... '9'	Source port of a potential communication partner Def.: <b>'00000'</b>
Source IP No. 3 for permitted access	53	15	'0' .. '9' and '.'	Source IP of a potential communication partner Def.: <b>'000.000.000.000'</b>

<sup>3</sup> If '00000' is defined for the server port, the server function is not activated. The second port number is currently not supported. It is to be regarded as a reserve.

<sup>4</sup> If the source IP check is activated, the source IP of the external communication partner must match completely.

<sup>5</sup> If the source port check is activated, the source port of the external communication partner must match completely.



Class 82/Parameter	Offset	Len	Values (ASCII)	Description
Source port no. 3 for permitted access	68	5	5 characters '0' ... '9'	Source port of a potential communication partner Def.: '00000'
Source IP No. 4 for permitted access	73	15	'0' .. '9' and '.'	Source IP of a potential communication partner Def.: '000.000.000.000'
Source port no. 4 for permitted access	88	5	5 characters '0' ... '9'	Source port of a potential communication partner Def.: '00000'
Source IP No. 5 for permitted access	93	15	'0' .. '9' and '.'	Source IP of a potential communication partner Def.: '000.000.000.000'
Source port no. 5 for permitted access	108	5	5 characters '0' ... '9'	Source port of a potential communication partner Def.: '00000'
Connection test via ping activated	113	1	'0' or '1'	'0': Ping function is switched off '1': Ping function is switched on <sup>6</sup> Def.: '0'
Interval time for ping test in minutes	114	4	'0000' to '9999'	A cyclic ping is executed on one or more URLs in the specified cycle. Def.: '0030'
IP address 1 for ping test	118	15	'0' .. '9' and '.'	Target IP of a potential communication partner for a ping <sup>7</sup> e.g.: '062.109.255.003'. Def.: '000.000.000.000'
IP address 2 for ping test	133	15	'0' .. '9' and '.'	Target IP of a potential communication partner for a ping e.g.: '062.109.255.003'. Def.: '000.000.000.000'
IP address 3 for ping test	148	15	'0' .. '9' and '.'	Target IP of a potential communication partner for a ping e.g.: '062.109.255.003'. Def.: '000.000.000.000'
IP address 4 for ping test	163	15	'0' .. '9' and '.'	Target IP of a potential communication partner for a ping e.g.: '062.109.255.003'. Def.: '000.000.000.000'
IP address 5 for ping test	178	15	'0' .. '9' and '.'	Target IP of a potential communication partner for a ping e.g.: '062.109.255.003'. Def.: '000.000.000.000'
Connection timeout on failed LTE/GPRS login attempt	193	3	'001' .. '999'	Time in seconds after which an LTE/GPRS login is repeated after a failed attempt.

<sup>6</sup> A ping monitoring function is currently not implemented

<sup>7</sup> A ping monitoring function is currently not implemented

Class 82/Parameter	Offset	Len	Values (ASCII)	Description
				Def: <b>'300'</b>
Dialling attempts on LTE/GPRS service until module reset	196	1	'0' .. '9'	Number of login attempts to the GPRS service until the module is reset. Def: <b>'3'</b>
Server timeout until disconnect	197	3	'000' .. '300'	Time in seconds after the module automatically terminates the TCP server service. '000': Module remains permanently logged on to the service Def: <b>'000'</b>
Waiting time after x failed GPRS login attempts	200	3	'001' .. '999'	Time in minutes that must elapse after a login error (incl. retries) until the LTE/GPRS module attempts to login again. Def: <b>'060'</b>
Ping Port (TCP Sync)	203	5	5 characters '0' ... '9'	Port on which the "IP ping" (TCP sync) is carried out. '00000'.. '65535'. Def: <b>'00080'</b>
	208			

### 7.3.5 Class 70 - IP Telemetry Client (1st IPT Master)

This class includes the general parameters for IP telemetry mode.

#### Factory configuration:

The factory configuration (**def.**) of class 70 is shown in bold.

Parameter	Offset	Len	Values (ASCII)	Description
String length IP destination address / host name	0	2	'00' .. '64'	If the parameter is set to '00', the IP telemetry mode is switched off. Def: <b>'00'</b>
IP destination address / host name	2	64	(0x20....)	IP address or host name under which the first IPT master can be reached, e.g.: '172.68.1.30' / 'test.dyndns.org'. Def: <b>'Empty'</b>
Destination port	66	5	('0' .. '9')	IP port number under which the first IPT master can be reached. Def: <b>'26862'</b>
Reserved	71	5	n/a	<b>Without function</b>
Number of login attempts	76	2	'01' .. '99'	A login attempt in GPRS-IPT mode always consists of GPRS Connect / TCP Connect / IPT Login and is executed in one block. Def: <b>'03'</b>
Reserved	78	2	n/a	<b>Without function</b> Def: <b>'03'</b>
String length IPT login name	80	2	'00' .. '32'	String length of the user name that is transferred when logging on to the IPT master. With length '00' the IMEI is used Def: <b>'00'</b>
IPT login name	82	32	(0x20....)	User name for logging on to the IPT master Def: <b>'&lt;IMEI&gt;'</b> The 15-digit IMEI number of the radio module is used as the default value. <b>Attention:</b> The character '/' (0x2F) may only be contained once! The default value '<IMEI>' cannot be read out at this point.
String length IPT password	114	2	'01' .. '32'	String length of the password for logging on to the IPT master Def: <b>'03'</b>
IPT password	116	32	(0x20....)	Password for logging on to the IPT master Def: <b>'PW0'</b>
Reserved	148	2	n/a	<b>Without function</b>
Reserved	150	1	n/a	<b>Without function</b>
Reserved	151	1	n/a	<b>Without function</b>
Reserved	152	3	n/a	<b>Without function</b>
Reserved	155	2	n/a	<b>Without function</b>
Reserved	157	1	n/a	<b>Without function</b>
Reserved	158	1	n/a	<b>Without function</b>

## Configuration

---

Reserved	159	3	n/a	<b>Without function</b>
Reserved	162	12	n/a	<b>Without function</b>
Reserved	174	3	n/a	<b>Without function</b>
Reserved	177	3	n/a	<b>Without function</b>
Reserved	180	1	n/a	<b>Without function</b>
Reserve for parameter extensions	181	0	n/a	For future extensions

### 7.3.6 Class 76 - P-Telemetry Client (2nd IPT Master)

This class includes the parameters to access a second IPT master if the first IPT master is not reachable.

#### Factory configuration:

The factory configuration (**def.**) of class 70 is shown in bold.

Parameter	Offset	Len	Values (ASCII)	Description
String length IP2	0	2	'00' .. '64'	Def: <b>'00'</b>
Server2 IP address / host name	2	64	(0x20 .. 0x7E)	IP address or host name under which the second IPT master can be reached, e.g.: '172.68.1.30' / 'test.dyndns.org'. Def: 'Empty'
Destination port	66	5	('0' .. '9')	IP port number under which the second IPT master can be reached. Def: '26862'
Reserved	71	5	n/a	<b>Without function</b>
Reserved	76	1	n/a	<b>Without function</b>
String length IPT login name	77	2	'00' .. '32'	String length of the user name that is transferred when logging on to the IPT master. With length '00' the IMEI is used Def: '00'
IPT login name	79	32	(0x20.... 0x7E)	User name for logging on to the IPT master Def: <b>'&lt;IMEI&gt;'</b> The 15-digit IMEI number of the radio module is used as the default value. <b>Attention:</b> The character '/' (0x2F) may only be contained once! The default value '<IMEI>' cannot be read out at this point.
String length IPT password	111	2	'01' .. '32'	String length of the password for logging on to the IPT master Def: '03'
IPT password	113	32	(0x20.... 0x7E)	Password for logging on to the IPT master Def: 'PW0'
Reserved	145	2	n/a	Without function
Reserved	147	1	n/a	Without function
<b>Reserve for parameter extensions</b>	148	30	n/a	For future extensions

### 7.3.7 Class 78 - Delay parameters

This class defines the redialling (LTE/GPRS network) or the login behaviour (IPT master) of the ZDUE-LTE-PLUS-VII.

#### Factory configuration:

The factory configuration (**def.**) of class 78 is shown in bold.

Parameter	Offset	Len	Values (ASCII)	Description
Reserved	0	40	n/a	<b>Without function</b>
Delay times between connection attempts at socket/IP level	40	40	<b>10</b> Values in the range '0000' ... '9999'	10 values á 4 digits [minutes]  Def: <b>2,4,6,10,15</b> <b>'000200040006001000150000000000000000'</b>
Reserved	80	40	n/a	<b>Without function</b>
<b>Reserve for parameter extensions</b>	120	30	n/a	For future extensions

## 8 Register data set of the ZDUE-LTE-PLUS-VII

The ZDUE-LTE-PLUS-VII uses a short set for register data. The output is done by means of EN 62056-21 protocol:

/? <device address of the ZDUE>!<CR><LF>

The register data set is structured according to the following table:

EDIS code	Field length	Format	Function
1-1:F.F	8	Hexadecimal	Error status
1-1:0.0.0	16 (Def. 8)	String	EVU - Identification 1
1-1:0.2.0	8	String	Firmware version of the ZDUE-LTE-PLUS-VII
1-1:0.9.1	6	hhmmss	Time
1-1:0.9.2	6	JJMMTT	Date
1-1:C.91.0	15	String	Firmware version of the radio module
129-72:23.7.0	15	String	Current IP address in GPRS mode

The register data record of the ZDUE-LTE-PLUS-VII contains the values for time and date that were previously written with the corresponding set command. If no time or date has been set yet, or if the device was without power, "0000000" is output accordingly as the time and/or date.

### Example

Register data set of the ZDUE-LTE-PLUS-VII:

```

1-1:F.F      (00000005)      Error status
1-1:0.0.0    (12345678)      EVU identification
1-1:0.2.0    ( 8.014)        Firmware version of the ZDUE
1-1:0.9.1    (135224)        Time (hhmmss)
1-1:0.9.2    (110326)        Date (yymmdd)
1-1:C.91.0   ( EFCR06A06M4G) Firmware version radio module
129-72:23.7.0 (29.9.18.87)   Current own IP address
!
T

```

**Error status format** The error status indicated in the register data set is the hexadecimal representation of a 32-bit number composed of the following bits of the operating status (in brackets the bit number. in the operating status word, see also 9.4) :

Bit 0	(Bit 08):	Voltage recovery
Bit 1	(Bit 09):	reserved "0 "
Bit 2	(Bit 10):	Parameter reset to factory configuration
Bit 8	(Bit 04):	Parameter checksum error
Bit 16	(Bit 05):	Parameter write/read error
Bit 17	(Bit 06):	reserved "0 "
Bit 18	(Bit 07):	reserved "0 "
Bit 24	(Bit 00):	reserved "0 "
Bit 25	(Bit 01):	reserved "0 "
Bit 26	(Bit 02):	reserved "0"



## 9 Communication commands according to EN 62056-21

The following sections document the commands supported by the ZDUE-LTE-PLUS-VII. The data set elements contained therein are described below.

The command descriptions use symbolic data set elements (e.g. for timestamps). Their structure is the same for all command categories.

1. Time stamp  
ZS7: yhhmmss
  - y = time zone (0=winter time, 1=summer time)
  - hh = hour (00..23)
  - mm = minute (00..59)
  - ss = second (00..59)
  
2. Time stamp  
DS7: yYYMMTT
  - y = time zone (0=winter time, 1=summer time)
  - YY= year (00..99)
  - MM= month (01..12)
  - DD= day (01..31)
  
3. Set password: String with max. 16 characters except for the characters '(', ')', '/', '!' or empty string

### 9.1 Error messages

Under special circumstances, the ZDUE-LTE-PLUS-VII will answer a command with an error message: <STX>(ERRORnn)<ETX><BCC>

The following error numbers 'nn' are used by the ZDUE-LTE-PLUS-VII:

Error number (nn)	Error
00	Invalid command (data set structure, content)
01	Unknown command (command ID, command type ID)
02	
03	
04	Invalid class
05	
06	
07	
08	
09	
10	
11	Invalid time/date (invalid values)
12	
13	
14	Serial number has already been set [W1-S96(20)(<data>)].

## 9.2 Set password

---

For the execution of various commands, the transfer of a setting password (as a 2nd data set) is required. Depending on the parameterisation, the following cases can occur during communication between the ZDUE-LTE-PLUS-VII and the head end system:

- No setting password parameterised in the ZDUE-LTE-PLUS-VII (string length = 0):

In this case, the ZDUE-LTE-PLUS-VII will not evaluate the transmitted setting passwords (all password-protected commands can be executed!).

The request to send the password (P0-Operand) when activating the programming mode may in this case be answered with the password command (P1 command, password arbitrary). Alternatively, the head end system can continue the communication by sending another permissible VDEW command.

- Set password parameterised in the ZDUE-LTE-PLUS-VII (default: '00000000').

All passwords sent by the head end system must match the parameterised one, otherwise the communication will be interrupted by a break command from the ZDUE-LTE-PLUS-VII. The request to send the password (P0 operand) when activating the programming mode must be answered with the password command (P1 command). The immediate sending of another VDEW command is not permitted.

## 9.3 Parameterisation commands

---

The parameters are set and read via W1 / R3 commands (ASCII coded characters).

The individual parameter segments are selected by the class; in principle, the command parameters 'Offset' and 'Length' can be used to access individual parameters or parameter ranges in a class. However, this is not supported by the ZDUE-LTE-PLUS-VII the classes can only be written or read completely ('Offset' and 'Length' of the class equal '0000').

9.3.1 Write class (complete)

<i>Function</i>	Write class (complete)
<i>Command format:</i>	<SOH> W1<STX> C<class> 000000(<data>)(set-password)<ETX><BCC>
<i>Note</i>	After executing this command, the data is initially stored in the volatile memory of the ZDUE-LTE-PLUS-VII. To transfer the data to the non-volatile memory, the parameter transfer command <b>W1P01()</b> (see chapter 9.3.3) must be executed.
<i>Example:</i>	<p>Set the parameters of the subgroup parameter class 79 to the following values:</p> <p>EVU identifier: '12345678'                  Device address: '74747474'                  Set password: '18871887'                  Head end system password active '0'.                  Head end system password: 'PW0'                  Communication ID: '1KGL923390R0003'                  Data format to the meter: '1'                  Mode C monitoring: '1'                  Transfer timeout: '99'</p> <p>...</p> <p>(The other parameters accordingly)</p>
	<pre> Command  /?99999999!&lt;CR&gt;&lt;LF&gt; Answer   /ABB61KGL923390R0003&lt;CR&gt;&lt;LF&gt; Command  &lt;ACK&gt;061&lt;CR&gt;&lt;LF&gt; Answer   &lt;SOH&gt;P0&lt;STX&gt;(00000001)&lt;ETX&gt;&lt;BCC&gt; Command  &lt;SOH&gt;P1&lt;STX&gt;(00000000)&lt;ETX&gt;&lt;BCC&gt; Answer   &lt;ACK&gt; Command  &lt;SOH&gt;W1&lt;STX&gt;C7900000000(081234567800000000 08747474740000000008188718870000000000PW000 0000000000151KGL923390R0003011990160000002 1000140000000001150)(00000000)&lt;ETX&gt;&lt;BCC&gt; Answer   &lt;ACK&gt;                 </pre>

### 9.3.2 Class reading in sub-blocks

<i>Function</i>	Class reading in sub-blocks
<i>Command format:</i>	<SOH> R3<STX> C<class> 00000000( )<ETX><BCC>
<i>Response format:</i>	<STX>0000(<record>)[<EOT>   <ETX>]<BCC>
<i>Legend:</i>	<p>0000 = Offset (ASCII character hexadecimal-coded)</p> <p>&lt;record&gt; = data of the class (max. 64 ASCII characters per sub-block)</p>
<i>Example:</i>	<p>Read class 79 with offset '0000', length '0000' (read operating parameters -&gt; several sub-blocks required):</p> <div style="border: 1px solid black; padding: 10px; margin: 10px 0;"> <pre> Command  /?99999999!&lt;CR&gt;&lt;LF&gt;           &lt;CR&gt;&lt;LF&gt; Answer   /ABB61KGL923390R0003&lt;CR&gt;&lt;LF&gt; Command  &lt;ACK&gt;061&lt;CR&gt;&lt;LF&gt;           &lt;CR&gt;&lt;LF&gt; Answer   &lt;SOH&gt;P0&lt;STX&gt;(00000001)&lt;ETX&gt;&lt;BCC&gt; Command  &lt;SOH&gt;P1&lt;STX&gt;(00000000)&lt;ETX&gt;&lt;BCC&gt;&lt;CR&gt;&lt;LF&gt; Answer   &lt;ACK&gt; Command  &lt;SOH&gt;R3&lt;STX&gt;C79000000()&lt;ETX&gt;,&lt;CR&gt;&lt;LF&gt; Answer   &lt;STX&gt;0000(0800000000000000000000000899999999000000000           80000000000000000000003PW00000)&lt;EOT&gt;&lt;BCC&gt; Command  &lt;ACK&gt;&lt;CR&gt;&lt;LF&gt; Answer   &lt;STX&gt;0040(000000000151KGL923390R000300099015           00000021000040000000001150)&lt;ETX&gt;&lt;BCC&gt;                     </pre> </div>

### 9.3.3 Parameter transfer command

<i>Function</i>	Take over parameters
<i>Command format:</i>	<SOH> W1<STX> P01()(Set Password)<ETX><BCC>
<i>Explanation</i>	<p>The following command is defined so that newly written parameters are taken over at a specific time.</p> <p>By executing this command, the data of the previously passed commands "write class" are taken over into the non-volatile memory. Before executing this command, the old parameters remain active.</p> <p>A readout of the data before a transfer by means of this command outputs the old values!</p> <p>Sending a <i>break</i> deletes the data temporarily set in the device by class write commands. This allows faulty "Write class" commands to be undone as long as the W1 command "Accept parameter" defined here has not been sent. In addition, the temporary data is discarded by a disconnect or an inactivity timeout that has occurred.</p>

### 9.3.4 Time / date commands

The time and date commands have no function in the ZDUE-LTE-PLUS-VII. They are implemented for reasons of compatibility with other devices and head end system programmes.

Reading the time or date from the ZDUE-LTE-PLUS-VII makes the values available that were previously written to the device with the *Set Time* or *Set Date* commands. These data are only stored volatile in the device and are therefore no longer available after disconnecting the supply voltage.

If no time is set, "0000000" is returned as the time; if no date is set, "0070101" is returned.

<i>Function</i>	Set time
<i>Command format:</i>	<SOH> W5<STX> 0.9.1(ZS7)(set password)<ETX><BCC>

<i>Function</i>	Read time
<i>Command format:</i>	<SOH> R5<STX> 0.9.2()<ETX><BCC>
<i>Response format:</i>	<STX>0.9.1(ZS7)<ETX><BCC>

<i>Function</i>	Set date
<i>Command format:</i>	<SOH> W5<STX> 0.9.2(DS7)(Set Password)<ETX><BCC>

<i>Function</i>	Read date
<i>Command format:</i>	<SOH> R5<STX> 0.9.2()<ETX><BCC>
<i>Response format:</i>	<STX>0.9.2(DS7)<ETX><BCC>

### 9.4 Operating status word

Events and error messages are recorded in the ZDUE-LTE-PLUS-VII an "operating status word". This is stored volatile in the RAM and is therefore lost in the event of a power failure. The status word can be read out of the device to determine the current operating status.

Bit in the status word	Displayed error state / event
Bit 0	<i>Reserved</i>
Bit 1	<i>Reserved</i>
Bit 2	<i>Reserved</i>
Bit 3	<i>Reserved</i>
Bit 4	Parameter checksum incorrect (EEPROM)
Bit 5	EEPROM write / read error
Bit 6	<i>Reserved</i>
Bit 7	<i>Reserved</i>
Bit 8	Voltage recovery
Bit 9	<i>Reserved</i>
Bit 10	Parameters reset to factory configuration
Bit 11	<i>Reserved</i>
Bit 12	<i>Reserved</i>
Bit 13	<i>Reserved</i>
Bit 14	<i>Reserved</i>
Bit 15	<i>Reserved</i>

---

**Note**

Other status information that can be read out from the ZDUE is:

- GSM field strength
- GSM network operator ID (e.g. 26201 for T-Mobile)
- GSM Location Area ID
- GSM Cell ID
- IMEI (International Mobile station Equipment Identity): Serial number of the radio module.
- IMSI (International Mobile Subscriber Identity): SIM card identification number.

These values are queried by the ZDUE-LTE-PLUS-VII via service command (see chapter 9.5).

---

The ZDUE-LTE-PLUS-VII allows the status word to be read out and reset. When reading out, the most significant bit is transmitted first, each bit is represented by an ASCII character '0' or '1'.

**9.4.1 Read status word**

<i>Function</i>	Read status word
<i>Command format:</i>	<SOH> R3<STX> S70()<ETX><BCC>
<i>Response format:</i>	<STX>S70(b16b15b14 <sub>b00</sub> )<ETX><BCC>.....
<i>Legend:</i>	bnn : '0' = event/status not occurred / inactive '1' = event/status occurred / active
<i>Example:</i>	Bit 8 (voltage recovery) is set in the status word.  <div style="border: 1px solid black; padding: 5px; margin: 10px 0;"> <pre> Command  /?99999999I&lt;CR&gt;&lt;LF&gt;           &lt;CR&gt;&lt;LF&gt; Answer   /ABB61KGL923390R0003&lt;CR&gt;&lt;LF&gt; Command  &lt;ACK&gt;061&lt;CR&gt;&lt;LF&gt; Answer   &lt;SOH&gt;P0&lt;STX&gt;(00000001)&lt;ETX&gt;&lt;BCC&gt; Command  &lt;SOH&gt;P1&lt;STX&gt;(00000000)&lt;ETX&gt;&lt;BCC&gt;&lt;CR&gt;&lt;LF&gt; Answer   &lt;ACK&gt; Command  &lt; SOH&gt;R3&lt;STX&gt;S70()&lt;ETX&gt;&lt;BCC&gt;&lt;CR&gt;&lt;LF&gt; Answer   &lt;STX&gt;S70(0000000100000000)&lt;ETX&gt;&lt;BCC&gt; Command  &lt; SOH&gt;B0&lt;ETX&gt;&lt;BCC&gt;&lt;CR&gt;&lt;LF&gt; </pre> </div>

**9.4.2 Reset status word**

<i>Function</i>	Reset status word
<i>Command format:</i>	<SOH> W1<STX> S70()<ETX><BCC>

**9.5 Service commands**

**9.5.1 Parameter reset to factory configuration**

<i>Function</i>	Parameter reset to factory configuration
<i>Command format:</i>	<SOH> W1<STX> S98( )<ETX><BCC>
<i>Explanation</i>	<p>This command loads the factory parameters. All customer-specific settings are overwritten.</p> <ul style="list-style-type: none"> <li><input type="checkbox"/> The overwritten parameters are stored in non-volatile memory. The device automatically reboots afterwards.</li> <li><input type="checkbox"/> This command is also permitted via the network (LTE/GPRS).</li> <li><input type="checkbox"/> This command is executed immediately (without sending an additional break) after receipt.</li> <li><input type="checkbox"/> The manufacturer passwords and the manufacturer device address are not reset by this command.</li> </ul> <p>After the automatic reboot, the factory setting applies</p>

**9.5.2 Remote reset**

<i>Function</i>	Remote reset of the ZDUE-LTE-PLUS-VII
<i>Command format:</i>	<SOH>W1<STX>S92( ) (<set password>) <ETX><BCC>
<i>Response format:</i>	<ACK>
<i>Explanation</i>	<p>This command triggers a warm start of the device. The command leads to a watchdog reset followed by a restart of the firmware.</p> <p>There is no change of parameters.</p> <p>This command is also permitted via the LTE/GPRS connection.</p>

**9.5.3 Write PIN**

<i>Function</i>	Write PIN
<i>Command format:</i>	<SOH>W1<STX>S93(<PIN_Len><PIN>)(<set password>) <ETX><BCC>
<i>Response format:</i>	<ACK>
<i>Legend</i>	PIN_Len: Length of PIN PIN: PIN to be set Set password: Set password parameterised in the ZDUE-LTE-PLUS-VII
<i>Explanation:</i>	This command sets the PIN in the device to the new value. The PIN on the card is not changed. Any PIN error status is deleted with this command. This command is also permitted via the LTE/GPRS connection.

**9.5.4 Read out parameter checksum**

<i>Function</i>	Read out parameter checksum
<i>Command format:</i>	<SOH> R3<STX> S61( )<ETX><BCC>
<i>Response format:</i>	<STX>S61(cccc)<ETX><BCC>
<i>Legend:</i>	cccc : Hex-coded 16-bit parameter checksum
<i>Explanation:</i>	This command is also permitted via the LTE/GPRS connection.

**9.5.5 Read out the firmware version of the ZDUE**

<i>Function</i>	Read out the firmware version of the ZDUE
<i>Command format:</i>	<SOH> R3<STX> S63( )<ETX><BCC>
<i>Response format:</i>	<STX>S63(version)<ETX><BCC>
<i>Legend:</i>	version : z. B. ZDUE_PLUS_VII_V8.014
<i>Explanation:</i>	This command is also permitted via the LTE/GPRS connection.

**9.5.6 Read the firmware version of the radio module**

<i>Function</i>	Read out the firmware version of the radio module
<i>Command format:</i>	<SOH> R3<STX> S64( )<ETX><BCC>
<i>Response format:</i>	<STX>S64(version)<ETX><BCC>
<i>Legend:</i>	version : .B. EFCR06A06M4G
<i>Explanation:</i>	This command is also permitted via the LTE/GPRS connection.

**9.5.7 Read version of the booter**

<i>Function</i>	Read version of the booter
<i>Command format:</i>	<SOH>R3<STX>S96(14)<ETX><BCC>
<i>Response format:</i>	<STX>S96(14)(<data>)<ETX><BCC>
<i>Legend:</i>	<Data>: Version of the booter, e.g. 5.005
<i>Explanation:</i>	This command is also permitted via the LTE/GPRS connection.



**9.5.8 Read out the position of the DIP switches/parameter status**

<i>Function</i>	Read out the position of the DIP switches/parameter status
<i>Command format:</i>	<SOH> R3<STX> S96(15)<ETX><BCC>
<i>Response format:</i>	<STX>S96(15)(0000p)<ETX><BCC>
<i>Legend:</i>	p :               Parameter state flag: 0 : User parameterisation active 1 : Default parameterisation active
<i>Explanation:</i>	This command is also permitted via the LTE/GPRS connection.

**9.5.9 Read mobile radio operating/module parameters**

<i>Function</i>	Read mobile radio operating/module parameters
<i>Command format:</i>	<SOH> R3<STX> S65( )<ETX><BCC>
<i>Response format:</i>	<STX>S65(dB)(Net-ID)(Location)(Cell-ID)(IMEI)(IMSI)<ETX><BCC>
<i>Legend:</i>	dB                GSM field strength (3-digit, decimal coded, z. B.: '075' => -75dBm, 'na' => not available)  Net-ID            Net-ID of the GSM network operator (max. 6 characters, e.g.: '26202'),  Location         GSM-Location Area ID (max. 4 digits, hex. coded), Cell ID          GSM Cell ID (max. 4 digits, hex-coded), IMEI             Serial number of the radio module (International Mobile station Equipment Identity, max. 20 characters), IMSI             SIM card identification number (International Mobile Subscriber Identity, max. 20 characters).  <i>Example (answer):</i> <STX>S65(075)(26202)(019B)(6434)(357042000459777)(262023800175922) <ETX>
<i>Explanation:</i>	This command is also permitted via the LTE/GPRS connection.

**9.5.10 Read out unique serial number:**

<i>Function</i>	Read out unique serial number
<i>Command format:</i>	<SOH> R3<STX> S96(20)<ETX><BCC>
<i>Response format:</i>	<STX>S96(20)( <date>;<ser.no.>;<lot.no.>)<ETX><BCC>
<i>Legend:</i>	Date:            Date in the format "YYYYMMDD" (e.g. 20200723) ser-no.:         Max. 12-digit serial no. (ASCII characters), leading zeros allowed. lot-no.:         Max. 24-digit lot no. (ASCII characters), leading zeros allowed
<i>Explanation:</i>	This command is also permitted via the LTE/GPRS connection.

### 9.5.11 Read LTE/GPRS operating parameters

<i>Function</i>	Read LTE/GPRS operating parameters
<i>Command format:</i>	<SOH> R3<STX> S96(12)<ETX><BCC>
<i>Response format:</i>	<STX>S96(12)(LocallP)(NetMask)(Gateway)(DNS1)(DNS2) <ETX><BCC>
<i>Legend:</i>	<p>LocallP            IP address currently assigned to the device. If the device is not currently assigned an address, "000.000.000.000" is output.</p> <p>NetMask            This value remains empty</p> <p>Gateway            This value remains empty</p> <p>DNS1                Current DNS1</p> <p>DNS2                Current DNS2</p> <p><u>Example (answer):</u> &lt;STX&gt;S96(12)(172.20.233.0)()()(139.007.030.125)(139.007.030.126)&lt;ETX&gt;&lt;BCC</p>
<i>Explanation:</i>	This command is also permitted via the LTE/GPRS connection.

---

## 10 Maintenance/troubleshooting

---

### 10.1 Maintenance

---

The ZDUE-LTE-PLUS-VII is maintenance-free.

### 10.2 Troubleshooting

---

If you encounter problems during operation, check the following table for possible solutions:

<b>Problem</b>	<b>Possible cause</b>	<b>Solution</b>
<b>Indicator lights are off</b>	The power supply is interrupted	Check connections to the power line and other power sources
<b>Device does not log on</b>	Incorrect PIN or APN	Check PIN or APN
	SIM card is not activated or in PUK status	Check activation and status
	SIM card is not activated for the selected service (UMTS, LTE)	Check activation and selected service
	Poor reception	Check positioning of antenna
	The device is in AT mode	Check the position of the DIP switch
<b>RS-232 and RS485 interface do not work?</b>	The wire jumper for bridging the CL interface is not plugged in.	If the CL interface is not used, it must be short-circuited with a wire jumper, otherwise the other interfaces of the ZDUE-LTE-PLUS-VII will not function.

## 11 Transport, storage and disposal

---

### 11.1 Transport

---

The ZDUE-LTE-PLUS-VII can be transported in individual cartons, collective cartons or wire mesh boxes.

The ZDUE-LTE-PLUS-VII can be transported by public transport (plane, road with any surface, ship, train). However, attention should be paid to the temperature and the following values should not be exceeded or fallen short of:

Temperature range:	-25 °C ...+85 °C
Relative humidity:	max. 95 %

### 11.2 Storage

---

Always disconnect the device from the power supply and remove all cables before storing it. Store the ZDUE-LTE-PLUS-VII a place protected from the weather and not subject to fluctuating temperatures.

Temperature range:	-25 °C ...+85 °C
Relative humidity:	max. 95 %

### 11.3 Disposal

---



Applicable in the European Union and other European countries with systems for the separate collection of recyclable materials. Old appliances must not be disposed of with household waste! This is why electrical appliances are marked with this symbol. If the appliance can no longer be used, every consumer is legally obliged to dispose of old appliances separately from household waste, e.g. at a collection point in his or her municipality/district. This ensures that old appliances are recycled properly and avoids negative effects on the environment.

WEEE registration number: 31323053

## 12 Technical data

### Power supply:

Input voltage (Un)	100 VAC to 230 VAC +/-10%, 50Hz60 VDC to 100 VDC +/-10% (reverse polarity protected)
Current consumption (In)	65 mA @ 230 VAC 140 mA @ 60 VDC
Typical power consumption	3.2 W; logged into radio network, occasional data transmission

### GSM interface:

Frequency bands	GSM/GPRS/EDGE: 900/1800MHz UMTS/HSPA+: 900/2100MHz LTE: 700/800/900/1800/2100/2600MHz
Mobile phone connection	GPRS; Support GPRS multi-slot class 33 (33 by default) LTE CAT-1; bands B1/ B3/ B7/ B8/ B20/ B28A
SIM card	ID-000 format (25mm x 15mm); 1.8V or 3V
Antenna connection	SMA or FAKRA-D, approx. 50 Ohm

### Meter interfaces:

CL1	Current interface (20mA) according to EN 62056-21, Mode A/C, up to 19.2 kbit/s
RS-232	Full duplex Signals: Rx, Tx, DSR, GND Speed: max. 38,400 baud (max. cable <length < 3 m) Cable length: max. 15 m
RS-485	Signals: RT+, RT Transceiver: max. 32 Speed: max. 19,200 baud Cable length: max. 1000 m
Configuration	EN 62056-21
Communication with meter	Meter mode: EN 62056-21: Mode C, Mode A (corresponds to transparent) AT mode: GSM data modem with AT command interface

### Galvanic separation:

Test voltage	Power supply L1, N against all interfaces: 3 kVAC, 50 Hz, 1 min. Between interfaces: 500 VAC, 50 Hz, 1min.
--------------	---

### Climate conditions:

Temperature	Operation: - 20°C ... +55°C; +55°C ... +65°C (limited) Storage: - 25°C ... +85°C
Humidity	0 - 95 % relative, non-condensing

**Housing:**

Type	Small plastic housing according to DIN 43861-2 for three-point mounting according to DIN 43857-5; sealable.
Material	Plastic, flammability class according to UL94: V0
Protection class	IP 51
Dimensions	H=180 mm, W=105 mm, D=70 mm
Weight	approx. 320 g

**Examinations/approval:**

EU conformity	<b>Simplified EU Declaration of Conformity</b>	
	<p>Sagemcom Dr. Neuhaus GmbH hereby declares that the radio equipment type ZDUE-LTE-PLUS-VII is in compliance with Directive 2014/53/EU. The full text of the EU Declaration of Conformity is available at the following internet address:  <b><a href="http://www.sagemcom.com/neuhaus">www.sagemcom.com/neuhaus</a></b></p> <p><b>Frequency bands:</b> GSM/GPRS/EDGE: 900/1800MHz                  UMTS/HSPA+: 900/2100MHz                  LTE: 700/800/900/1800/2100/2600MHz</p> <p><b>Transmit power:</b> max. 33dBm = 2W at GSM 900                  max. 30dBm = 1W with GSM 1800                  max. 24dBm = 0.25W with UMTS/HSPA+                  max. 23dBm = 0.20W with LTE</p>	
Applied standards	Radio module	GCF compatible
	RF spectrum	EN 301 511 V12.5.1 EN 301 908-1 V11.1.1 EN 301 908-2 V11.1.2
	EMC	EN 301 908-13 V11.1.2 DRAFT EN 301 489-1 V2.2.3 DRAFT EN 301 489-52 V1.1.0 EN 55032 [2015] class B EN 61000-6-2 [2019]
	Health	EN 55024 [2010] + A1 [2015] EN 62479 [2010]
	Electrical safety	EN 62368-1 [2014] + AC [2015] Protection class 2, overvoltage category III