

DCI85HD KD

RECEIVER

User manual



SAGEMCOM

Congratulations!

This Receiver is an innovative product from the latest generation of Sagemcom digital TV receivers, dedicated to Digital Cable Television. It allows easy reception of digital programs, including those broadcast in High Definition.

Once you have connected your Receiver and performed the initial installation, you will be able to watch and enjoy all the cable TV and radio channels which are not scrambled and you are entitled to. You can update your Receiver if new functions or services become available.

The Sagemcom Receiver follows a continuous development strategy. Therefore, we reserve the right to make changes and improvements to the product described in this user manual without any prior notice.

This product complies with EMC directive 89/336/EEC.

CE marking:

The CE marking certifies that the product complies with the essential requirements of the Directive 1999/5/EC concerning radio equipment and telecommunication equipment, and of Directives 2006/95/EC concerning safety, 2004/108/EC concerning electromagnetic compatibility and ErP 2009/125/EC concerning ecodesign requirements, defined by the European Parliament and Council to minimize electromagnetic interferences, ensure the safety of users and their equipment and protect their health, and minimize the impact of products on the environment.

The CE declaration of conformity can be viewed in the support section of the Sagemcom site www.sagemcom.com, or it can be obtained from the following address:

Sagemcom Broadband SAS - Customer relations department
250 route de l'Empereur
92848 Rueil-Malmaison Cedex - FRANCE

Copyright © Sagemcom Broadband SAS
All rights reserved
Sagemcom is a registered trademark.

This "HD TV" Television Receiver complies with the "HD TV" Minimum Requirements. The "HD TV" Logo is a trademark of DIGITALEUROPE. HDMI, HDMI logo and High-Definition Multimedia Interface are trademarks or registered trademarks of HDMI Licensing LLC.

DTS is a registered trademark of Digital Theater Systems, Inc.

Macrovision is a registered trademark of Rovi Corp.

Manufactured under license from Dolby Laboratories. "Dolby" and the double-D symbol are registered trademarks of Dolby Laboratories Inc.





Macrovision Copyright notice

This product incorporates copyright protection technology that is protected by U.S. patents and other intellectual property rights. Use of this copyright protection technology must be authorized by Rovi Corporation, and is intended for home and other limited viewing uses only unless otherwise authorized by Rovi Corporation. Reverse engineering or disassembly is prohibited.

Read this first!

For your safety and comfort, we urge you to carefully read the **Safety recommendations** on page 3 before attempting use.

This document makes use of symbols designed to help the reader identify the information supplied:

Symbol	Definition
 CAUTION	Indicates important safety information. Failure to respect these notes may lead to serious or even fatal injury. Read these notes carefully. You will find them in the Safety section of this manual.
 WARNING	Indicates important safety information. Failure to respect these notes may lead to minor to moderate injury, or damage to the apparatus or equipment. Read these notes carefully. You will find them in the Safety section of this manual.
 Important	Indicates points to be read with special attention when using the device, and explanations of probable reception issues. Read these explanations carefully.
 Note	Indicates additional explanations about device functions, and instructions for resolving user errors.

Safety recommendations

Use of the Receiver is subject to safety measures designed to protect users and their environment.

Where to put your Receiver?

In order to guarantee the correct operation of your Receiver, you must:

- place it indoors to protect it from lightning, rain, and sun rays,
- place it in a dry and well ventilated area,
- keep it away from heat sources such as radiators, candles, lamps, etc.
- protect it from dampness, place it on a flat surface from where it will not fall off and children don't have access to,
- do not place anything on top of your Receiver (as it would restrict ventilation): the ventilation slots located on the casing prevent your Receiver from overheating. If you place the Receiver in a compartment, leave a space of at least 10 cm on each side and 20 cm on the front and back of the Receiver,
- connect it directly to the mains with the provided cords, the socket must be near the Receiver and easy to access. The use of an extension cable (with multi-points) is not recommended.



Warnings and safety instructions

NEVER OPEN THE Receiver! YOU RISK GETTING AN ELECTRIC SHOCK.



- Use only the power cord supplied with the Receiver to connect it to the mains. Other practice may be dangerous.
- Connect the Receiver to the mains in accordance with the installation instructions in this document and the indications mentioned on the identification label (voltage, current, frequency of electricity network).
- As a precaution, in case of danger, the mains adapters act as a disconnecting mechanism for the 230V power supply. That is why it is imperative that you connect the Receiver to a power outlet located nearby and easily accessible.
- The Receiver must be used within a temperature range of between 0 °C and 40 °C.
- You must imperatively connect the power cord to the Receiver before connecting the power cord to the power socket.
- To avoid short-circuits (fire or electrocution hazard), do not expose your Receiver to dampness. Do not place any object containing liquid (vase for example) on the appliance. The Receiver must not be splashed with liquid. If liquid is dropped, dripped onto the Receiver, unplug it immediately from the mains and consult your supplier.
- Take care not to allow liquids or metal objects to enter the Receiver through the ventilation slots.
- Avoid reconnecting the Receiver after it has been subjected to large changes in temperature.
- The Receiver must be disconnected from mains supply (from the power outlet or rear panel) before any modification of connection between TV, VCR or antenna.
- In the event of a storm, it is advisable to unplug the antenna. Even if the Receiver and the television set are disconnected from the power supply, lightning can still damage them.
- Only a personnel approved by the manufacturer can repair the Receiver. The non-observance of these safety precautions can result in forfeiture of the guarantee.

Batteries

Batteries are easily swallowed by young children. Do not allow young children to play with the remote control.

To avoid damaging the remote control, only use identical batteries or batteries of equivalent type. The batteries provided are not rechargeable.

Interference

Do not place the Receiver near appliances that may cause electromagnetic interferences (for example loudspeakers). This could affect Receiver operation and distort the picture or sound.

Cleaning the Receiver

The outer casing of the Receiver can be cleaned with a soft and dry cloth. Do not use any type of abrasive pad, scouring powder or solvents, such as alcohol or turpentine, as they could damage the surface of the Receiver.

Environment

Preservation of the environment is an essential concern of the manufacturer. The desire of the manufacturer is to operate systems observing the environment and consequently it has decided to integrate environmental performances in the life cycle of its products, from manufacturing to commissioning, use and elimination.

Meaning of logos present on the product or its packaging



The crossed-out dustbin sign stuck on the product or its accessories means that at the end of its life, the product is subject to selective collection and must not be thrown away in unsorted household waste.



The looped arrow sign means that the packaging may be recycled and must not be disposed of with household waste.



The green logo means that a financial contribution is paid to an approved national organisation to improve packaging recovery and recycling infrastructures.



The logo with three arrows shown on the plastic parts means that they may be recycled and that they must not be disposed of with household waste.

Product recycling and disposal

To facilitate recycling, please respect the sorting rules set up locally for this kind of waste.

If your product contains batteries, they must be disposed of at appropriate collection points.

European regulations ask you to dispose of products belonging to the family of electrical and electronic equipments () selectively:

- At the collection points made available to you locally (drop-off centre, selective collection, etc.),
- At sales points in the event of the purchase of similar equipment.

In this way you can participate in the re-use and upgrading of Electrical and Electronic Equipment Waste, which can have an effect on the environment and human health.

European Directive on Waste Electrical and Electronic Equipment (WEEE)

In the context of sustainable development, the reduction of wastes to be eliminated by reusing, recycling, composting and energy recovery is strongly advised.

In order to comply with this directive which is applicable to EEEs sold after 13/08/2005, your Receiver will be taken back free of charge and recycled by the distributor of the EEE within the limits of the quantity and types of equipment bought from them. These appliances which contain substances potentially dangerous to human health and the environment will be recycled.

Directive on the Restriction of use of certain hazardous substances in electronic equipment (ROHS)

Your Receiver along with the batteries supplied comply with the directive relating to the RoHS – dangerous materials such as lead, mercury or cadmium are not used. This avoids environmental hazards and any risks to the health of personnel at the recycling centres. The batteries of the remote control can be removed simply.

Note: When the batteries of the remote control are worn out, please dispose of them at a collection point and not with household waste.

Electrical consumption of the Receiver

To reduce the consumption of your Receiver, you are recommended to place it in standby mode when not in use. We recommend you to turn off the Receiver or unplug it from the mains if you will not be using it for a prolonged period of time.

Contents

1. Product Overview	9		
1.1 Package contents	9		
1.2 Elements and functionalities: Front side of the device	10		
1.3 Elements and functionalities: Back side of the device	10		
1.4 Remote control	11		
Batteries	11		
2. Connections to the network and connecting additional devices	12		
2.1 Connection to the cable network	12		
RF Cable connection	12		
2.2 Connection to TV	13		
Connection to High Definition TV with HDMI® port	13		
Connection to a standard definition TV with SCART connection	13		
2.3 Connection to the internet	14		
Internet connection via wireless stick	14		
Internet connection via network cable	14		
2.4 Connection to the VCR / DVD recorder	14		
2.5 Connection with a home cinema amplifier ..	15		
2.6 Connection to a hi-fi unit	15		
2.7 Powering On / Off the Receiver	16		
3. Initial installation	17		
3.1 Preparation: Device checks the device settings	17		
3.2 Language settings	17		
3.3 The five steps of the installation wizard	18		
Step 1: Channel search	18		
Step 2: Set up favorite channels	18		
Step 3: Setting up an internet connection	19		
Step 4: Select energy mode	20		
Step 5: Summary	20		
4. Basic functions	21		
4.1 Selecting a TV channel	21		
Using P+/P- or 0-9	21		
Program information bar	21		
Using the channel list	22		
Detailed program information	23		
4.2 Volume settings	23		
Volume	23		
Mute	24		
4.3 Language settings for audio and subtitles and selection of option channels	24		
Language for audio	24		
Language for subtitles	24		
Selecting option channels	24		
4.4 Teletext	25		
4.5 Listen to radio	25		
Selecting a radio channel	26		
Categories and other options in radio mode	26		
5. Setting a timer	27		
5.1 Set timer	27		
Set flags in program information bar	27		
Set timer in electronic program guide (EPG)	27		
Set timer in search results	28		
Delete timer	28		
5.2 Set timer manually	28		
5.3 Displaying and using timers	29		
6. Electronic program guide (EPG), search function and Select Video (video library)	31		
6.1 Electronic Program Guide (EPG)	31		
6.2 Search	32		
Search by keyword	32		
Search by category	33		
Search results	34		
Local Search	34		
6.3 Select Video (online video library)	35		
Access to Select Video	35		
Selection of videos	35		
7. Settings	37		
7.1 System Update	37		
Software update	37		
Search for updated software	37		
Channel search	38		
Delete additional channels	39		
Search additional channels	39		
Start a channel search	39		
Reset to factory default	40		
Update EPG	40		
7.2 System set-up	41		
Language	41		
Audio	41		
Picture	43		
Energy settings	45		
Internet	46		

7.3	Protection of minors	50
	Change Parental Control PIN	50
	Change Adult PIN	51
	PIN request when ordering Select Video	51
	PIN-protect timer	52
7.4	Timer settings	52
	Manual timer	52
	Timer extensions	53
7.5	Favorites	53
	Add favorites	53
	Delete favorites	54
	Sort favorites	54
7.6	Service	55
	Support by phone	55
	Service messages	55
7.7	System Check	55
	Device Info	55
	Smartcard	56
	TV Signal	56
	VOD Signal	56
	HDMI	56
	TV picture	56
	Audio	56
	Network settings	57
	Back channel	57
	Test IP Connection	57
7.8	Settings overview	58
8.	Software update	62
9.	Universal remote control	63
9.1	Programing the universal remote control ...	63
9.2	Selection of the volume control	64
9.3	Reading out the 4-digit code	64
9.4	Reset the universal remote control	64
9.5	Brand Code List	65
10.	Troubleshooting	74
11.	Support	75
12.	Explanation of terms	76
13.	Specifications	77

1 Product Overview

Your Receiver is a digital receiver that lets you watch all the cable TV and radio channels which are not scrambled and you are entitled to.

1.1 Package contents

The package of your new device includes:

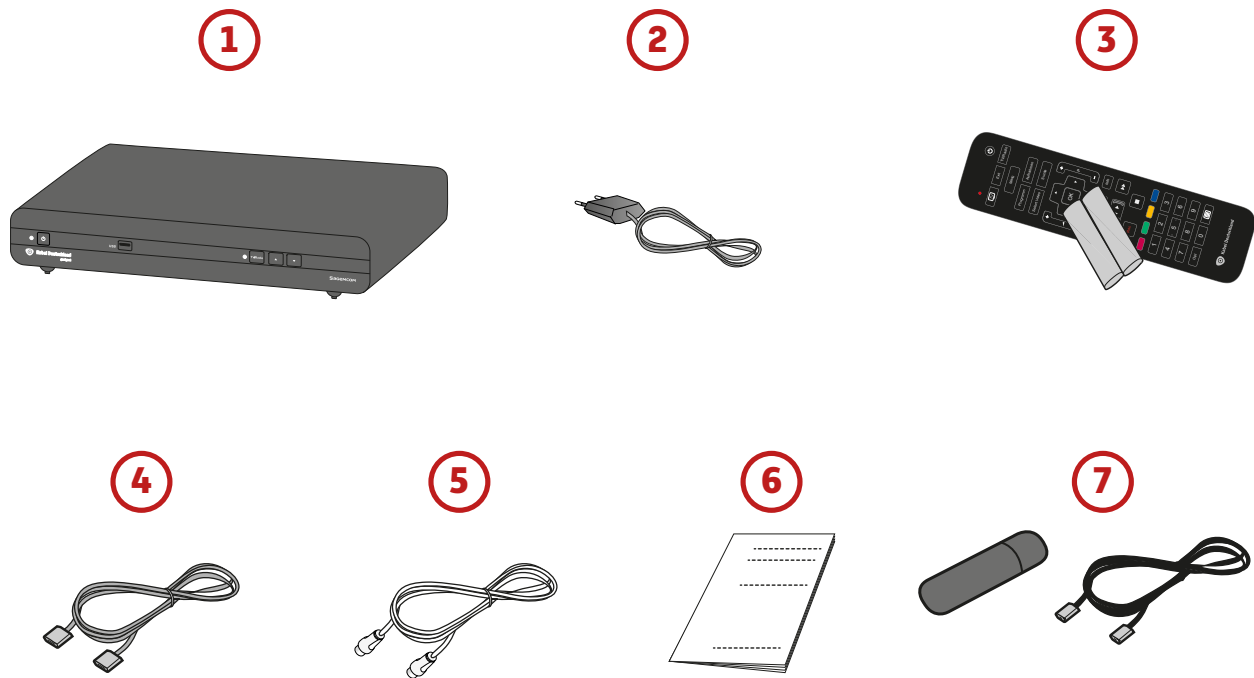

Item	Description
1	Receiver
2	Power cord
3	Remote control with 2 batteries (AAA)
4	HDMI lead for connection to the HDTV
5	Antenna cable to connect to the cable network
6	Quick installation guide
7	WLAN-Stick and cable

In addition, a smartcard from Kabel Deutschland is provided for the operation of the device.

1.2 Elements and functionalities: Front side of the device

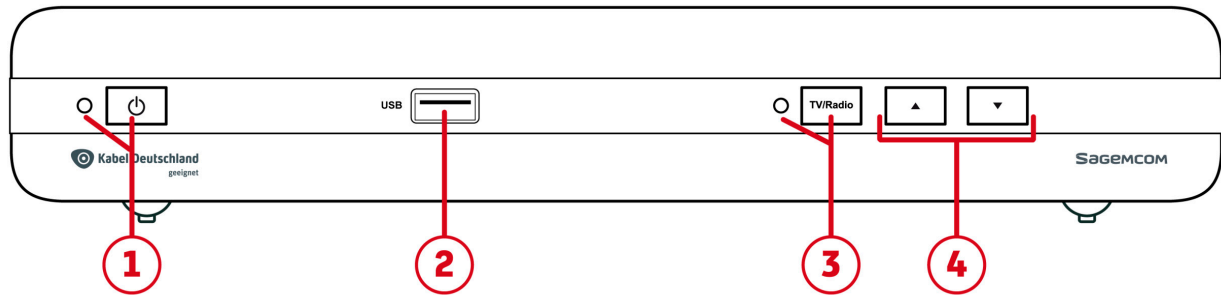

Item	Description	Item	Description
1	STANDBY button Switch to Standby/Wake up from standby <ul style="list-style-type: none"> • Red: Device in standby • Green: Device is running 	3	TV/radio button Switch between TV and radio channels <ul style="list-style-type: none"> • orange: radio mode active
2	USB port	4	P+/P- changing channels

1.3 Elements and functionalities: Back side of the device

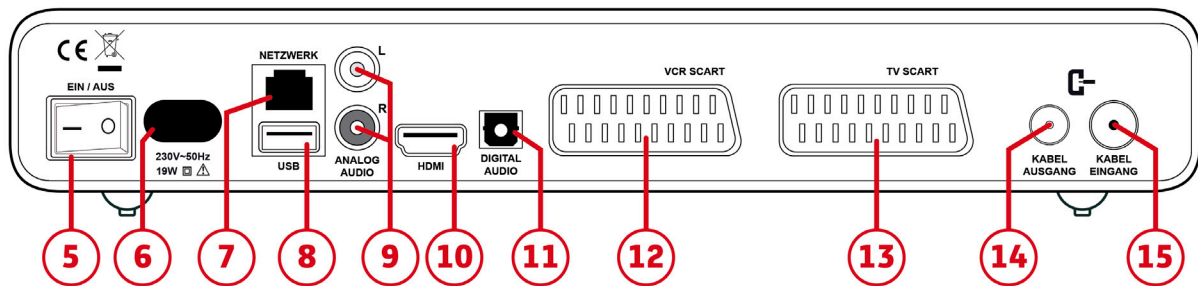

Item	Description	Item	Description
5	On/Off switch	11	DIGITAL AUDIO connector (Optical S/PDIF)
6	Power supply connector	12	SCART connector (to TV)
7	Ethernet port (RJ45)	13	SCART connector (to VCR or DVD Recorder)
8	USB port	14	Cable signal output
9	Analog AUDIO connectors (ANALOG AUDIO L/R) to Hi-fi system or TV	15	Cable signal input
10	HDMI DIGITAL VIDEO AUDIO connector		

1.4 Remote control

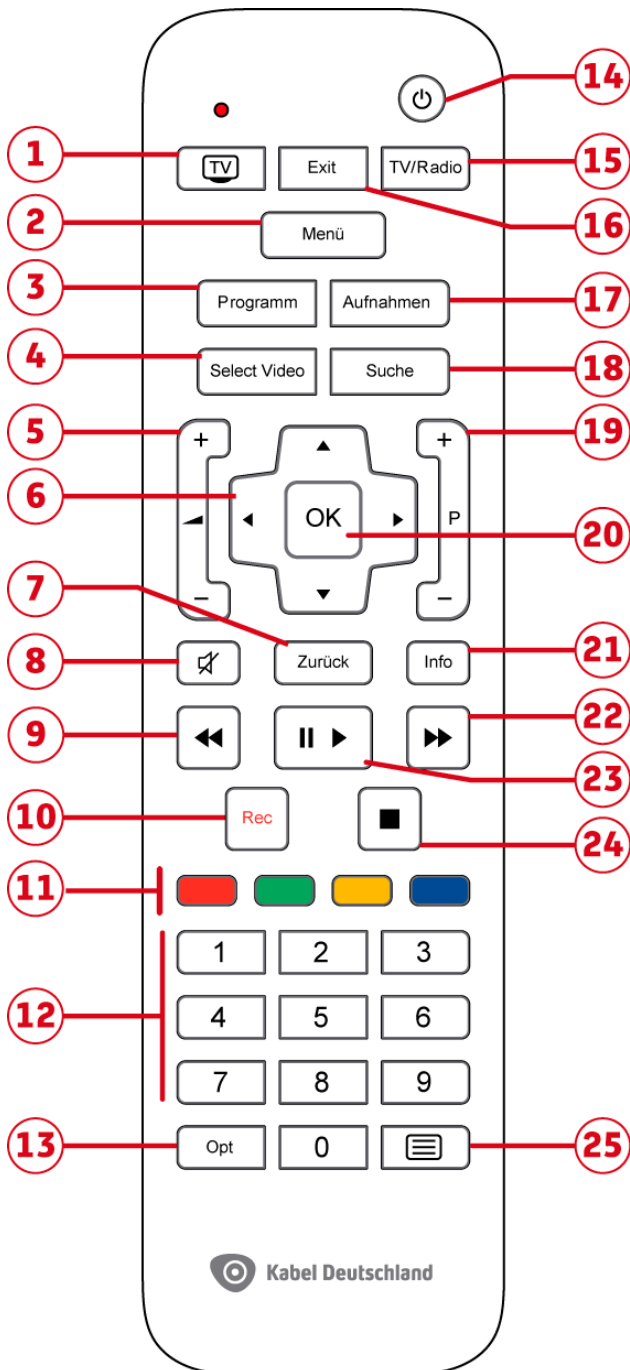

Button	Functions
1	TV: Switch to TV mode, if programmed. In TV mode, you can control your TV with this remote (see chapter 9, Using the universal remote). The unit is in TV mode, the LED light flashes.
2	MENÜ: Open and close main menu
3	PROGRAMM: Show electronic program guide (EPG)
4	SELECT VIDEO: Open online video library Select Video (Video on Demand, VOD), internet connection necessary. This service is not yet available everywhere in Germany.
5	V+/V-: Adjust the volume
6	NAVIGATION: Browse menu, electronic program guide (EPG), program information bar and other functionalities
7	ZURÜCK: Return to the previous screen or mode
8	MUTE: Turn the sound on or off
9	REWIND: Rewind program or recorded program, switch to other day in electronic program guide (EPG)
10	REC: Timing a program or prepare a timer using the electronic program guide (EPG).
11	COLOR KEYS: Select options in the On Screen Display (OSD), menus and messages, that are displayed on the screen
12	0-9: Choose programs and options from the On Screen Display (OSD)
13	OPT: Displays options for the current program (Audio Language / Subtitle, option channels). Shows program information for prime time in electronic program guide (EPG)
14	STANDBY: Switch to Standby/Wake up from standby
15	TV/RADIO: Switch between TV and radio channels
16	EXIT: Close a screen or a mode, return to the last viewed program, switch from TV mode to Receiver mode
17	AUFNAHMEN: : Displays the timed program list
18	SUCHE: Starts a search for programs in electronic program guide (EPG), in online video library Select Video and recordings
19	P+/P-: Jump to next / previous channel, display next / previous page in electronic program guide (EPG), browse in multipage lists / references
20	OK: Show program information bar, confirm a selection
21	INFO: Show informations for current program, in electronic program guide (EPG) and program search
22	FAST FORWARD: Forward switch to other day in the electronic program guide (EPG)
23	PLAY/PAUSE: Play / pause a recorded program, switch to time-shifted mode
24	STOP: Stop a recording, stop playing a recorded program, stop the time shift mode and return to live TV program
25	TELETEXT: Show teletext pages, if available

Batteries

The remote control needs two batteries (AAA) to operate. The direction to insert the batteries is labeled in the battery compartment. The batteries are not rechargeable.

2 Connections to the network and connecting additional devices

Check if the package is complete before installing the Receiver (see chapter 1.1, **Package contents**).

Make sure that the devices to be connected (Receiver, TV, VCR ...) are disconnected from the power supply.

2.1 Connection to the cable network

To make sure that your Receiver can receive all the cable TV and radio channels which are not scrambled and you are entitled to, you must check first of all that your home is connected to cable network.

2.1.1 RF Cable connection

1. Connect the antenna cable input of the Receiver with the antenna socket (antenna cable provided).
2. Connect the antenna cable output of the Receiver with the antenna socket of the TV or VCR/DVD Recorder (antenna cable not provided).

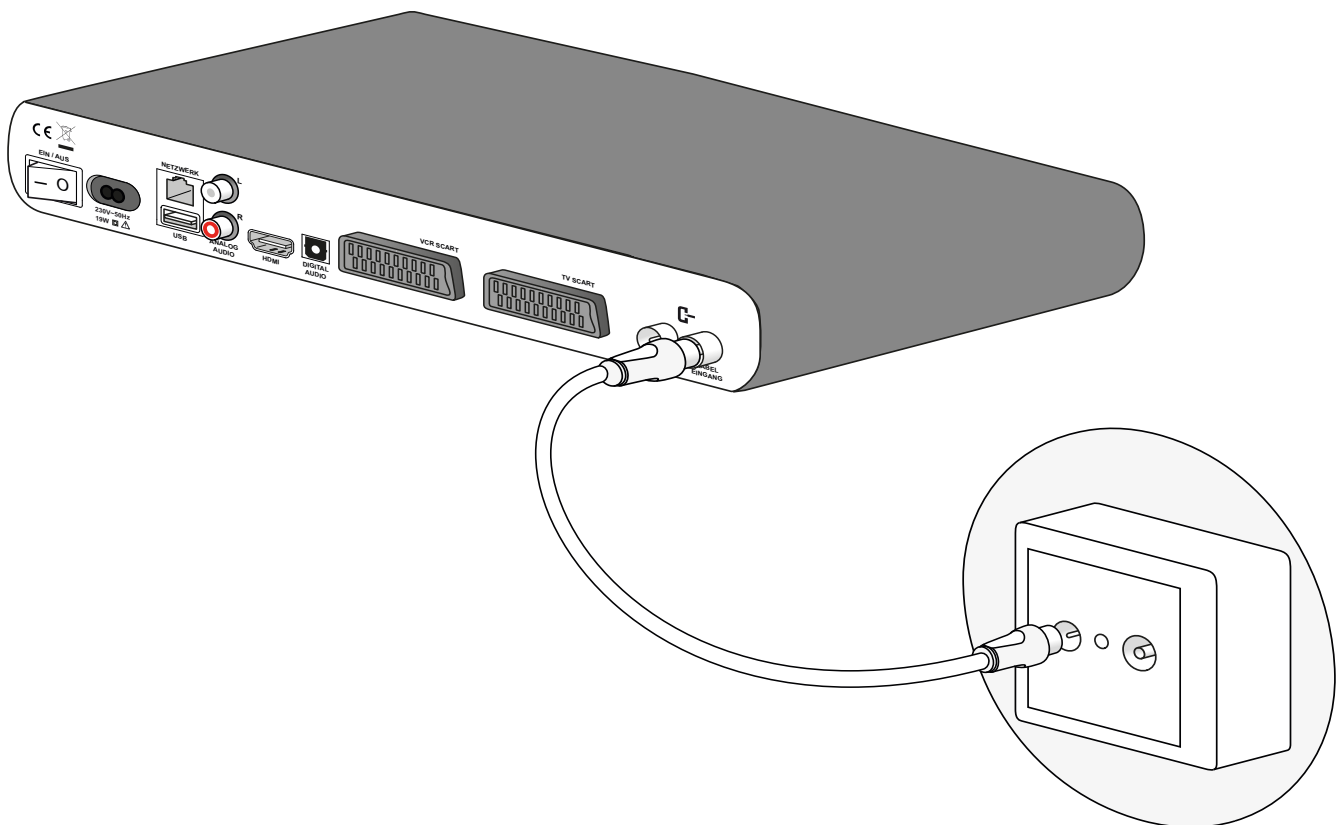

2.2 Connection to TV

Note



If you have a TV with HDMI® port, please use only the HDMI® cable to connect the Receiver to TV.

2.2.1 Connection to High Definition TV with HDMI® port

In order to take advantage of high-definition television (HDTV), connect the HDMI® port on your digital Receiver through the HDMI® cable (provided) to the HDMI® port on your HD TV.

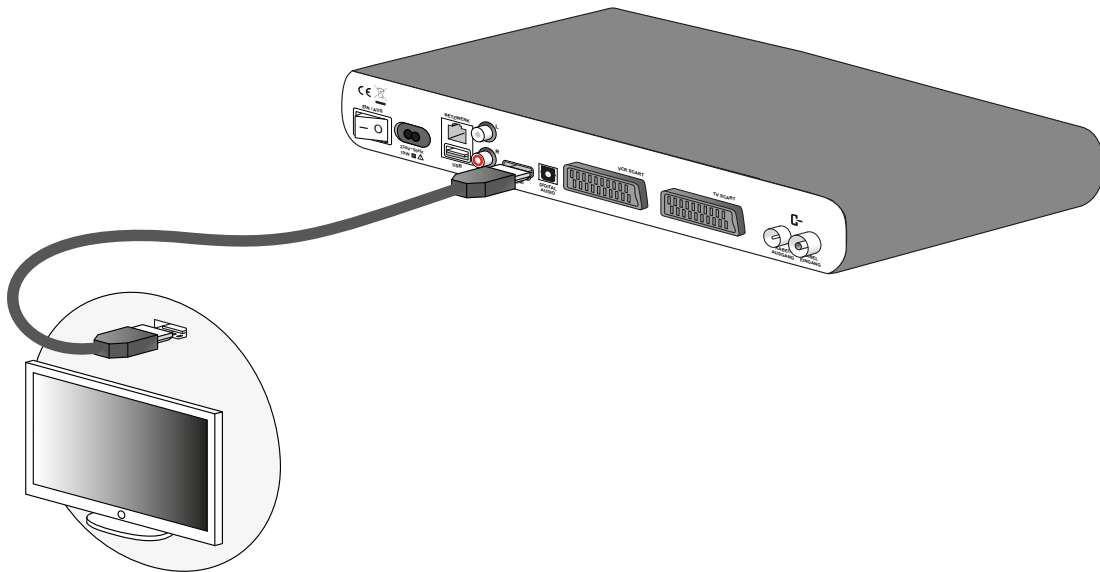

2.2.2 Connection to a standard definition TV with SCART connection

Connect the TV SCART connector on the Receiver through a SCART cable (not provided) with a free SCART socket on your TV.

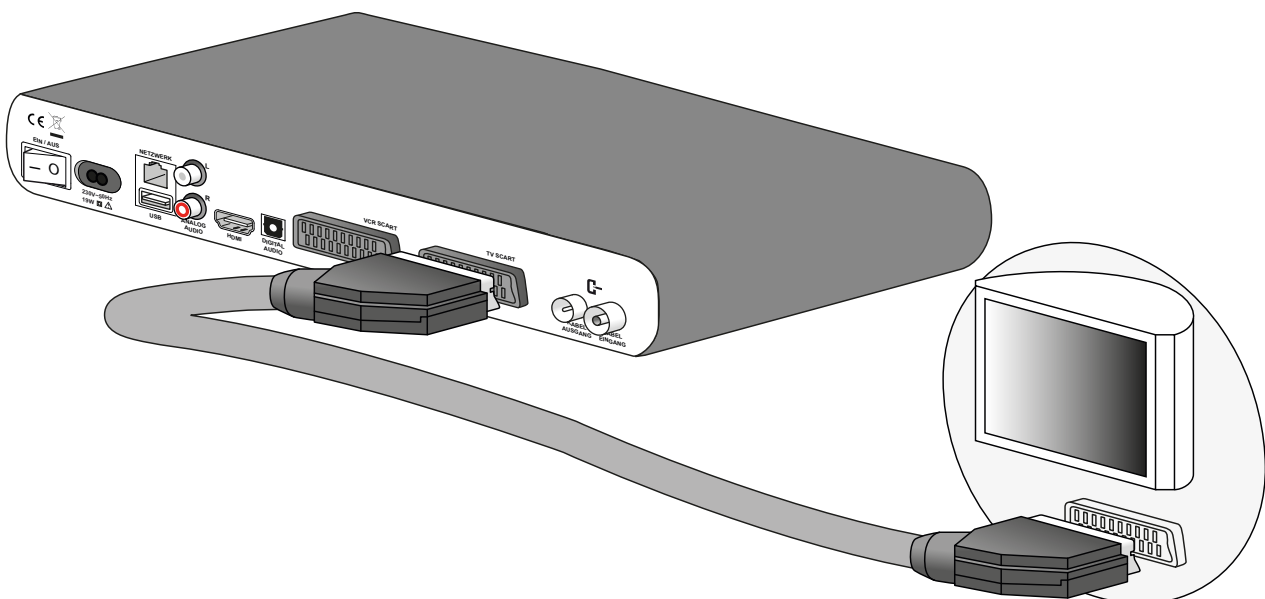

2.3 Connection to the internet

With an internet connection you have numerous other offers from Kabel Deutschland. To use them, connect your Receiver to the internet, either through the wireless stick or via a network cable (LAN cable).

2.3.1 Internet connection via wireless stick

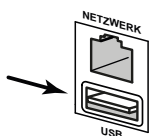

Slide the WLAN-Stick into the USB port for the WLAN dongle below the Network connector (RJ45). If the Receiver is connected to the power supply after all devices were connected, the wireless stick automatically starts. You may be prompted to enter the necessary data later.

2.3.2 Internet connection via network cable

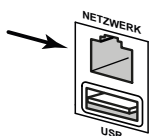

If you wish to connect your Receiver to the internet using a network cable with RJ45 connectors (LAN cable), plug in such a network cable (not provided) into the network port (RJ45) on the back of the Receiver. Plug the other end of the network cable to a free network connection to your internet router. You may be prompted to enter the necessary data later.

2.4 Connection to the VCR / DVD recorder

Connect the VCR SCART connector on the back of your Receiver with a free SCART socket on your VCR-/DVD-Recorder (cable not provided).

Note



If your VCR / DVD recorder has more than one SCART socket, select the TV or EXT1 port.

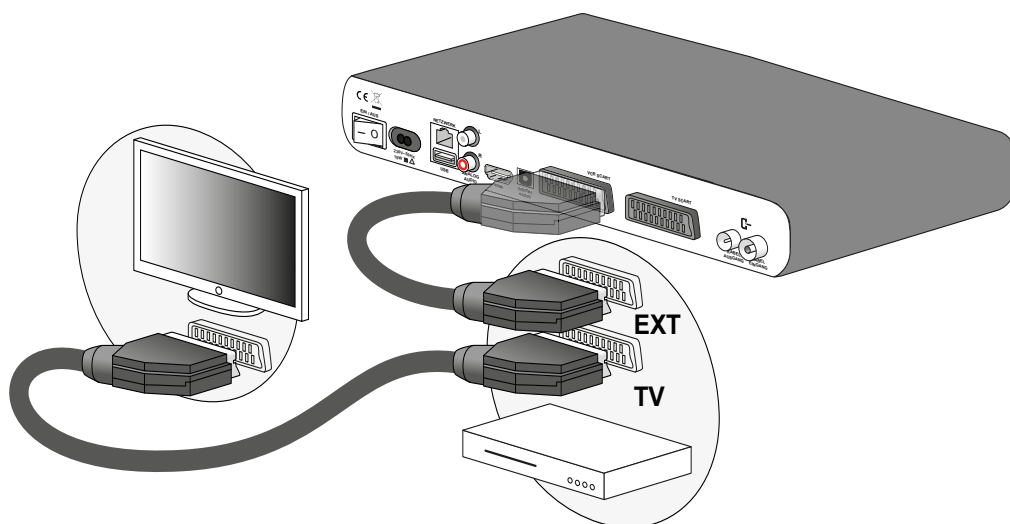

2.5 Connection with a home cinema amplifier

Some programs are broadcast with DTS or DOLBY DIGITAL sound. To fully enjoy this high sound quality it is recommended to connect your Receiver via the optical S / PDIF connection with a home cinema amplifier.

Use an optical S / PDIF cable (not supplied) to connect the DIGITAL AUDIO port of the Receiver to the DIGITAL AUDIO port of the home cinema amplifier.

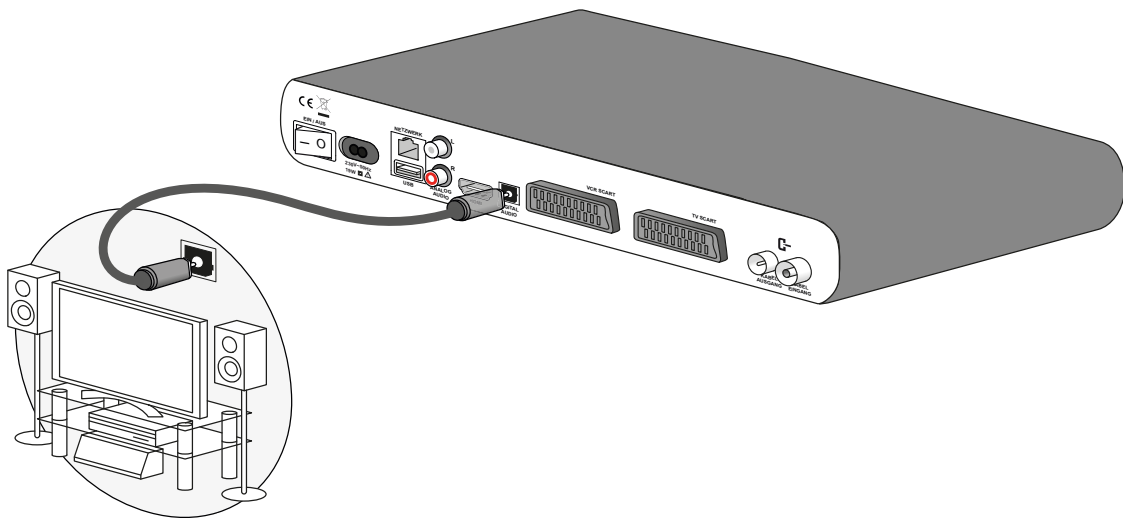

2.6 Connection to a hi-fi unit

To enjoy digital broadcasts in high sound quality and to listen to radio channels with switched off TV, connect the two analog AUDIO terminals (ANALOG AUDIO L / R) of the Receiver to the AUDIO terminals of your hi-fi system (cable not provided). This is only possible if you do not use the two analog AUDIO terminals (ANALOG AUDIO L / R) of the Receiver for connecting a TV.

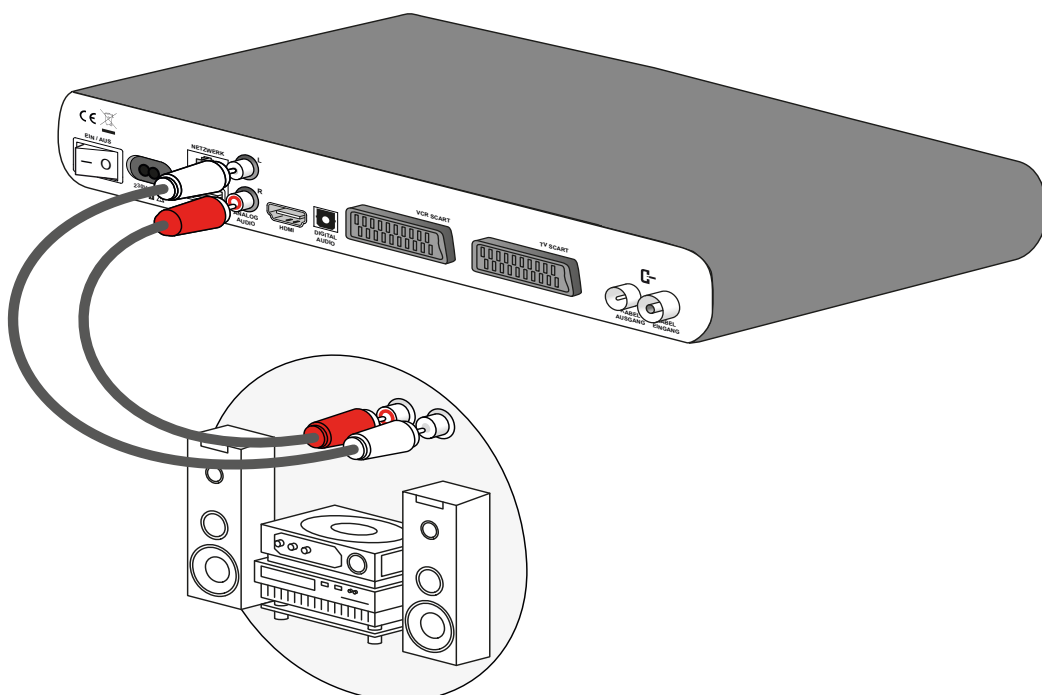

2.7 Powering On / Off the Receiver

You have all the equipment (Receiver, TV, VCR) connected? Connect the Receiver to the power network and turn it on. To turn on the Receiver proceed as follows:

1. Make sure that the power switch "On / Off" on the back of the Receiver is set to "Off" (position 0).
2. Now connect the power cord to the power connector of the Receiver.
3. Plug the power cord into a power outlet near the equipment so you can easily access it.
4. Press the "On / Off" button to switch the Receiver on (position I).

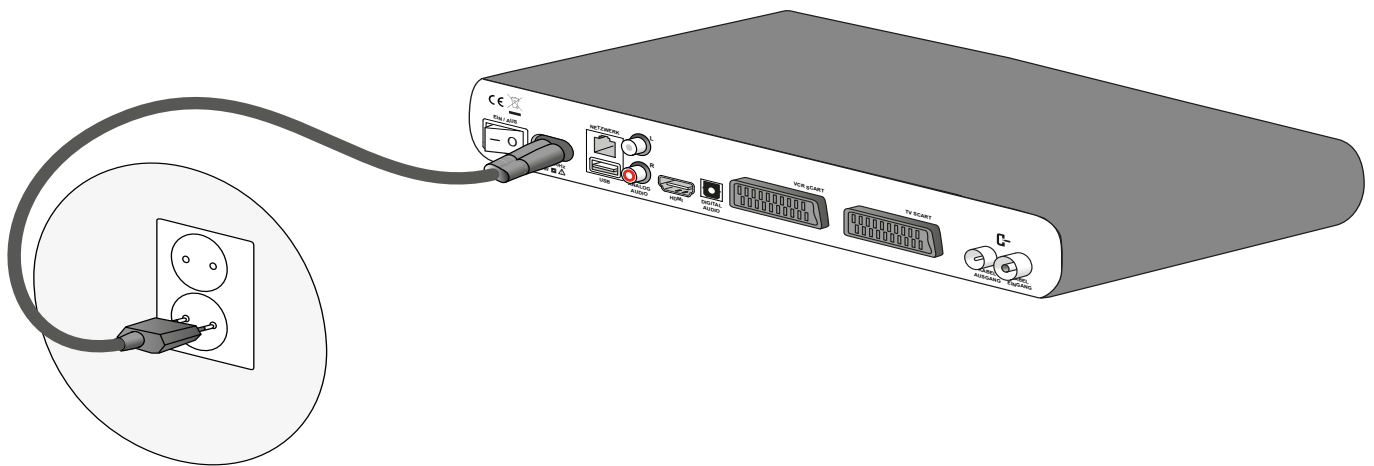

The initial installation of your Receiver will start automatically.

If you need to turn off the Receiver (for example, before a long period without using it), proceed as follows:

1. Press the STANDBY button on the remote control or on the front of the Receiver to switch the Receiver to standby mode.
2. Press the "on / off" switch on the back of the Receiver to turn off the Receiver (position 0).
3. Unplug the power cord from the socket.

3 Initial installation

If the Receiver is plugged in and turned on for the first time, the installation wizard starts.

1. Turn on your TV. If your TV does not automatically recognize the connected and powered Receiver, select the AV source to your TV (HDMI ®, analog or SCART AUDIO / VIDEO connector), on which the TV is currently connected to the Receiver.
2. Open the cover of the smartcard reader on the front of the Receiver. Slide the smartcard into the card slot. The smartcard must be inserted with the chip facing down.

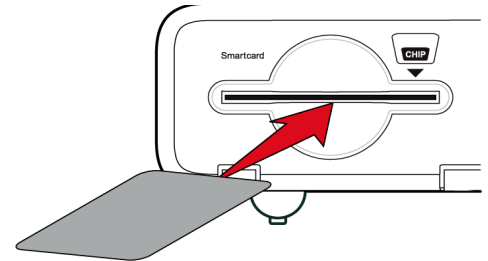

3.1 Preparation: Device checks the device settings

The following tests are performed by the installation wizard automatically. Your intervention is not required normally.

The Receiver searches for the cable signal. If no signal is detected, make sure that the antenna cable is properly connected. If the test has been interrupted, press on your remote control to proceed with the installation.

If the Receiver does not find a signal, contact the customer service of Kabel Deutschland.

The Receiver verifies that you have inserted the smartcard into the device. You received a smartcard from Kabel Deutschland, insert it into the smartcard reader. The smartcard must be inserted with the gold chip facing down. If you do not have the smartcard at hand, press on the remote control to continue the installation without smartcard. Until you use the smartcard, you can only use free channels.

The Receiver automatically searches the cable network for new and improved software for your Receiver. If new software is available, the Receiver downloads it and reboots.

3.2 Language settings

The default language for the operation of your Receiver is German. If you want to set a different language, press on the remote control. You can choose between the languages German, English, Turkish and Russian. Use the keys to select a language and confirm your selection by pressing .

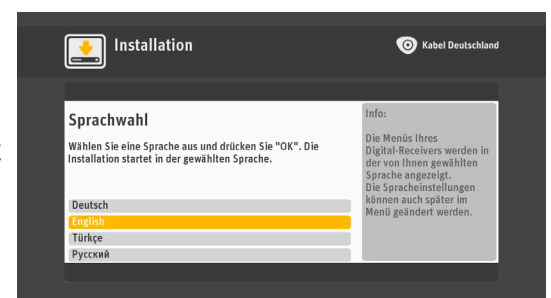

Note



The assignment of the button on your remote changes depending on the steps you perform. During installation, the current function assignment of the button always appears at the bottom right on your television screen.

3.3 The five steps of the installation wizard

In five steps, the installation wizard will guide you through the installation. Please follow the instructions on the screen carefully. If necessary, react with your remote control. Simply use the keys ▲ ▼ around the button and then confirm your selection by pressing .

3.3.1 Step 1: Channel search

The Receiver automatically checks the cable for TV and radio channels and stores them in places 101 to 999.

After the completion of the channel search, the total number of TV and radio channels is displayed in the installation screen. Exit the channel search by pressing .

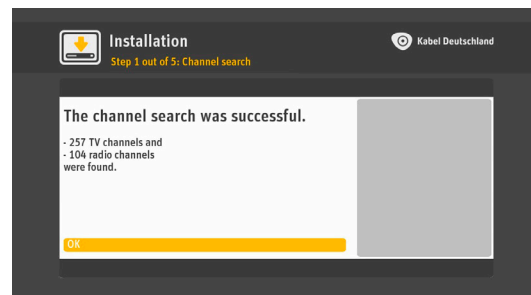

3.3.2 Step 2: Set up favorite channels

The channel search normally finds several hundred channels. You can now set up your favorite channels and their place in the list of favorite channels. Places 1 to 100 are reserved for your favorites. To begin, press .

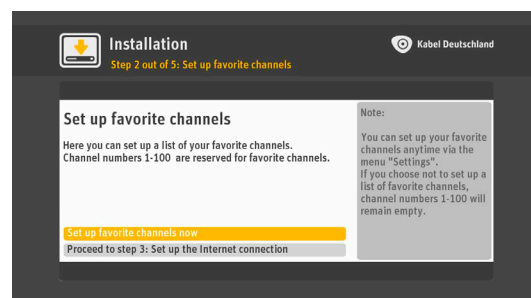

Note



If you do not want to create a list now, skip this menu. You can later press on your remote to enter the main menu. Then select **Settings** first, then **Favorites** (see chapter 7.5, **Favorites**). By choosing **Add** the list of TV channels is displayed. You can now create your favorites list as described. Without a favorites list the positions 1 to 100 remain unassigned.

1. The list of TV channels is displayed. Now proceed by pressing the keys ▲, ▼ or the **P+** / **P-** button on your remote control to browse through the channel list and select which channel you want to add to your favorites list. If you want to add a channel to your favorites list, press while the yellow marker is on the name of the channel. The selection is indicated by a green check mark next to the channel name.
2. If your list is complete, press ◀ on the remote control. A window appears in which you are prompted to confirm your selection. By pressing you store your entire favorite list.
3. To change the order of the channels in your favorites list, move down with the arrow key ▼ to the entry **Rearrange**. Your favorites are displayed. Do you want to move a channel in the favorites list, press while the yellow marker is on the program's name. Now the program can be moved using the keys ▲, ▼.
4. To complete sorting, press the arrow button ◀. Confirm the selected order of your favorites list by pressing .

3.3.3 Step 3: Setting up an internet connection

If you are connected to the internet you can use the Kabel Deutschland's online video store "Select Video". This service is not yet available everywhere in Germany. Furthermore, by using an internet connection you can review previous searches, the list of your recorded programs and a list of your favorite channels.

On the TV screen you see how to connect the Receiver to the internet. Select how to connect to the internet using the keys ▲, ▼ on the remote control: via the provided wireless stick or via a network cable (LAN cable) (with network cable, continue with step 2).

If you do not want to connect the Receiver to the internet at the moment, use the arrow button ▼ and on your remote control to select **Proceed to step 4: Select Energy Save Mode.**

1. If you want to connect via the WLAN-Stick, make sure that the WLAN-Stick is plugged into the USB port for WLAN-Stick under the network connector (RJ45) on the back of the Receiver and that the WLAN key is at hand. The wireless key is a string in the form of a password that protects access to your wireless internet access from unauthorized third parties. The wireless key is usually found in the documentation of your wireless router, the wireless access point to the internet. It is strongly discouraged to operate a wireless internet access in Germany without protection by a wireless key for reasons of data protection, data security and for legal liability.

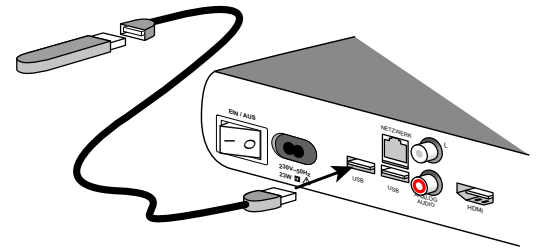

Now select the yellow highlighted line **Via the Kabel Deutschland wireless LAN stick** by pressing on your remote to establish an encrypted connection between WLAN-Stick and wireless router using a WLAN key.

You have additionally the option of selecting **Continue with WPS** using the arrow key ▼ on your remote control. WPS stands for Wi-Fi Protected set-up and is another technology for establishing wireless connections, but with lower level safety.

If wireless networks are in range, they are now displayed. Choose with the keys ▲, ▼ on the remote control, with which wireless network to connect the Receiver. When the name of the network is highlighted in yellow, select this network pressing on your remote.

Now, an on-screen keyboard is displayed to type the WLAN key. The wireless key is usually between 8 and 63 characters long and can consist of numbers, letters and special characters. Usually you have to distinguish between lowercase and uppercase letters. To enter the WLAN key, move the yellow highlight using the four keys ▲, ▼, ◀, ▶ on your remote control to the first character of the Wi-Fi key, and then press on your remote control. The character appears in the input line on the screen keyboard. Enter all characters of the wireless key. Use the **ABC** field in the screen keyboard and press on your remote to set the lowercase letters shown in the screen keyboard to uppercase if necessary. Use the field **!&?** in on the on-screen keyboard and press on your remote to display the special characters available. If the key is entered completely and correctly, finish the input via the field **Input ready** on the on-screen keyboard and press on your remote control. Now, the Receiver checks the network and internet connection. If the Receiver is connected to the internet, the message **The internet connection has been set up** appears. In addition, the LED light flashes on the wireless stick.

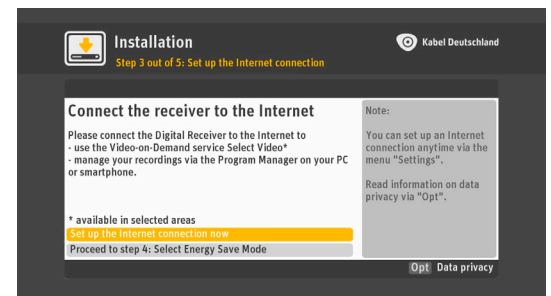

2. If you choose to connect via a network cable (LAN cable), check if the network cable is connected to the Receiver and to the router as shown in **chapter 2.2.2, Connection to a standard definition TV with SCART connection**. Press ▼ and on your remote control to select **Via a LAN cable**. The device will automatically establish an internet connection.

If the internet connection is lost, it can be established later pressing on your remote control and selecting **Settings** (see chapter 7.2.5, **Internet**).

3.3.4 Step 4: Select energy mode

In the fourth step you decide whether your Receiver consumes less energy overall but starts slowly, or if you wish a rapid operation of the Receiver but want to take into account a higher overall energy consumption of the device. Select one of the modes: **Active**, **Quick Start** and **Keep Standard**.

The default is the **Standard** mode, it causes the lowest power consumption and a longer start-up phase.

The **Active** mode has the highest power consumption and keeps the equipment ready at any time.

The **Quick Start** mode allows you to choose the times at which the device remains in Active mode and when it falls into the Standard mode. Use the keys ▲, ▼ and press on your remote control to select one of the specified modes.

If you have selected the **Quick Start** mode, enter the start time, for example 1 7 0 0 for 17:00 hrs (=5 p.m.), using the number buttons on your remote control.

Use the arrow button ▼ and press on your remote control, to select for how many hours the Receiver shall remain active. Use the arrow button ▼ and press on your remote control to choose on which days this mode should be active, for example, **Daily** or only on **Mondays, Wednesdays and Sundays**.

Save your settings pressing on your remote.

The message **The Energy Mode has been selected** appears on the TV screen, confirm it pressing on your remote.

You may press on your remote control and **Settings** at any time to change the power mode later (see chapter 7.2.4, **Energy settings**).

3.3.5 Step 5: Summary

After choosing the power saving mode in step 5, you receive a summary of the successful installation. Now you will see a list of the settings you have made during the installation.

Now press on your remote to confirm the yellow marked field **Watch TV** and go to the TV program.

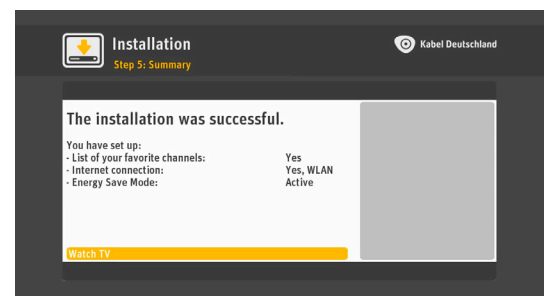
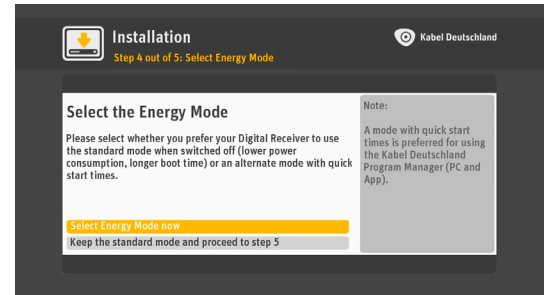

4 Basic functions

4.1 Selecting a TV channel

4.1.1 Using P+/P- or 0-9

To change channels press the **P+** or **P-** button on the remote control or enter the channel number directly using the numeric keys on the remote control. You can also switch to the last viewed channel using the button .

4.1.2 Program information bar

Each time you change the channel, the program information bar appears on the TV screen. It can also be displayed while watching a program by pressing  or using the four keys **▲**, **▼**, **◀**, **▶**.

The program information bar shows you the current program and the program for the coming 2 hours at a glance.

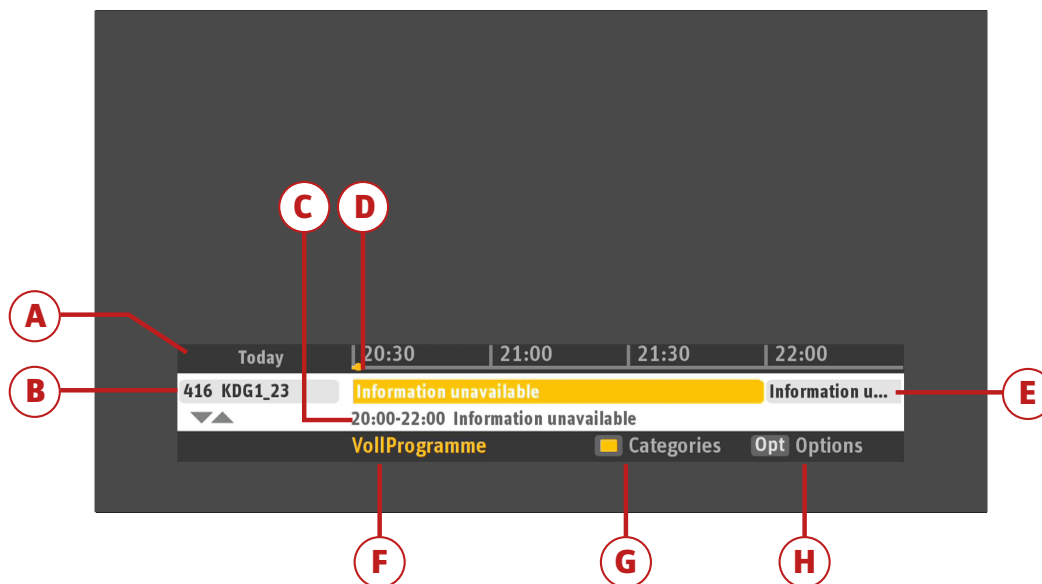

A	Day of broadcast	E	Current and next program
B	Channel number and name	F	Channel category
C	Title, start time and end time of the broadcast	G	Choose category
D	Elapsed time	H	Show options for this program

Use the keys **◀** and **▶** to scroll through the information regarding the current program and upcoming programs. You can display the time and the transparency of the information bar pressing  on your remote and **Settings, System set-up, Picture, OSD Transparency** (see chapter 7.2.3.6, **OSD Transparency**).

4.1.3 Using the channel list

During a program you can display the program information bar by pressing **OK** on your remote control or using the four keys **▲**, **▼**, **◀**, **▶**.

Press **▲** or **▼** to display the channel list.

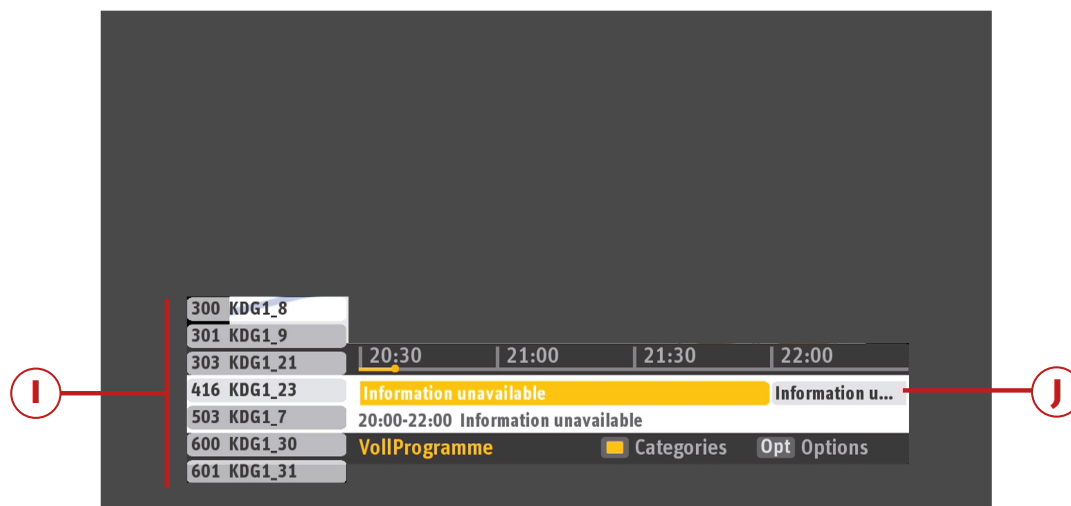

Press **▲** and **▼** to scroll through the channel list (**I**). The program information bar shows the broadcast data for the selected channel (**J**).

To switch to a channel in the list, mark it with the buttons **▲** or **▼**, then press **OK**.

4.1.3.1 List of favorites

If you have favorite channels you watch frequently, you can add them to your TV favorites list in the program information bar: your favorites are listed first for faster selection (channels 1 to 100 depending on the number of favorites). The main channel list follows, from channel number 101 to 999 depending on the number of channels found in the cable network.

For more information about creating and managing favorites, see chapter 7.5, **Favorites**.

4.1.3.2 Categories

To allow easy access to channels in a particular category, proceed as follows: press the yellow button on the remote control, select a category using the buttons **▲** or **▼** and press **OK**. The Channel list now shows the first channel in the selected category.

4.1.4 Detailed program information

To view more information about a program, press **Info**. Depending on availability, a detailed description of the program is displayed.

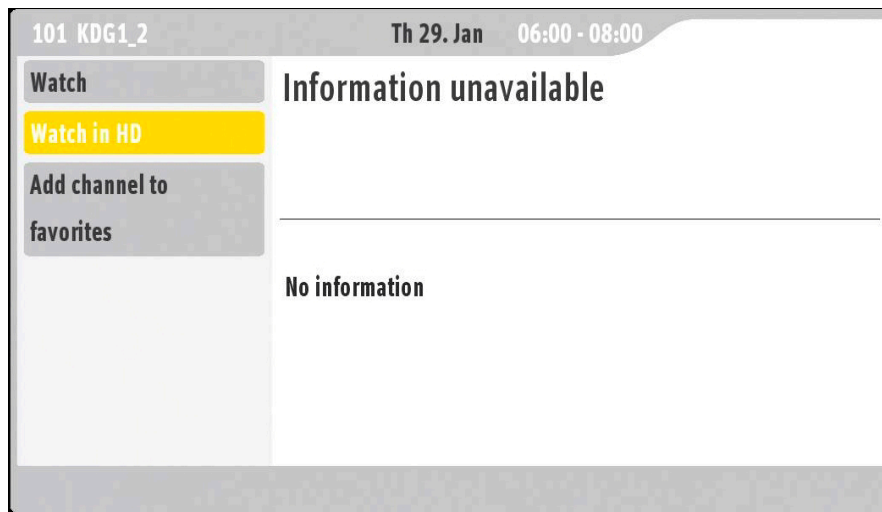

Use the keys **P+** or **P-** to scroll through the information pages.

Depending on the mission, you can select different actions within the information page:

Action	Description
Watch	View the program.
Watch in HD	Watch the channel in HD if you have an activation for the selected channel.
Timer	Set the timer.
Channel to favorites	Add the channel broadcasting the program to the Favorites.

Use the buttons **▲** or **▼** to select an action and press **OK** to confirm.

To close the program information screen and move to the last viewed program, press **Info** or **Exit**.

4.2 Volume settings

Note





The following settings affect the sound that can be heard on TV, but not on the VCR SCART connector, on the analog AUDIO connector (ANALOG AUDIO L / R) for Hi-fi system and on the DIGITAL AUDIO port.

4.2.1 Volume

Adjust the volume using the volume buttons on your remote control. If you want to increase the volume, press **▲+**. If you want to decrease the volume, press **▼-**.

4.2.2 Mute

If you want to mute the sound heard on the TV, use the button . Pressing  again turns the sound on again.

4.3 Language settings for audio and subtitles and selection of option channels

Note









All changes are immediately reflected in the program that you are watching. The temporary adjustments will be lost if you switch to another channel.



For a permanent change of language or settings for subtitles, press







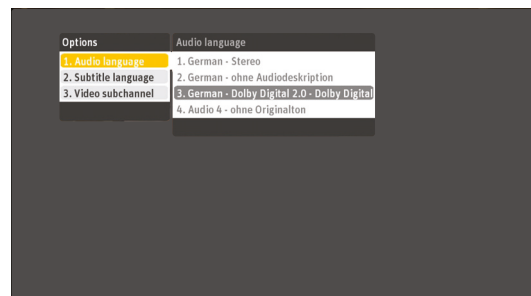

 on your remote and select **Settings, System set-up, Language** (see chapter 7.2.1, **Language**).

4.3.1 Language for audio

1. Press  to display the options bar.
2. Select **Audio language** using  or  and press  or .
3. Select the language using  or  and press .











4.3.2 Language for subtitles

1. Press  to display the options bar.
2. Select **Subtitle language** using  or  and press  or .
3. Select the language using  or  and press .



4.3.3 Selecting option channels

1. Press  to display the options bar.
2. Select **Video subchannel** using  or  and press  or .
3. Select the language using  or  and press .



4.4 Teletext



You can view teletext pages with additional information on television programs, if this service is supplied by the channel.

Press  to open the teletext page for the channel you are watching.

To make teletext pages appear transparent so that you can track the current program in the background, press  again.

To scroll through the teletext pages, either select a page using the number buttons on your remote control or press the **P+** or **P-** button on the remote control.

If the channel provides more screen options and services, select them using the color keys on the remote control.

To change back to the program from the teletext pages press  and .

4.5 Listen to radio

The radio mode offers the same features as the TV mode.

Press  on your remote to switch between TV mode and radio mode. On the TV screen the selected channel and the current program are displayed.

If you press  or one of the keys **▲**, **▼**, **◀**, **▶** on the remote, the channel information is displayed as in TV mode.

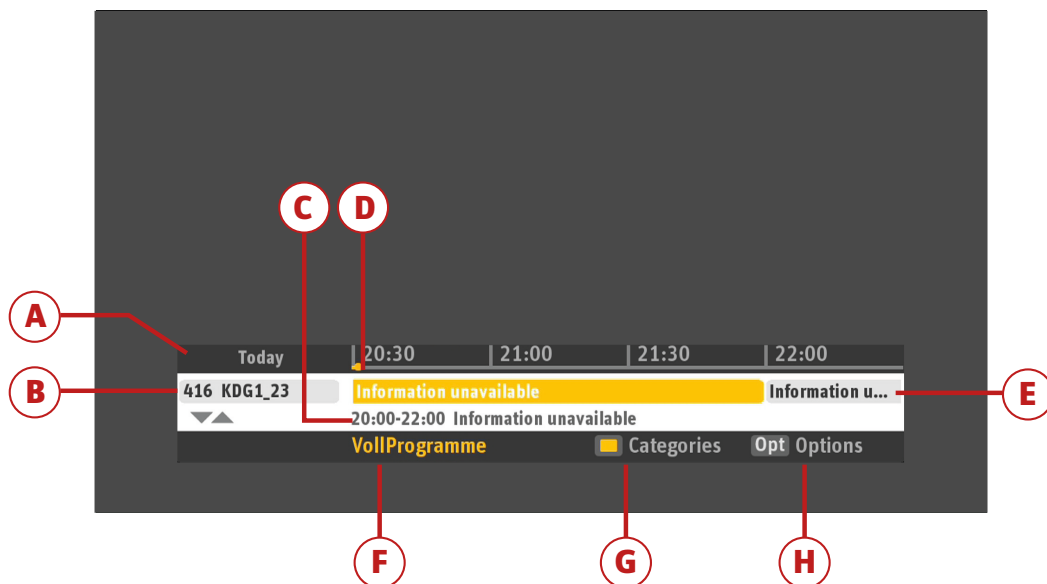

A	Day of broadcast	E	Current and next program
B	Channel number and name	F	Channel category
C	Title, start time and end time of the broadcast	G	Choose category
D	Elapsed time	H	Show options for this program

4.5.1 Selecting a radio channel

Press **P+** or **P-** on the remote control to change channels or enter a channel number using the numeric keys on the remote.

Use the keys ◀, ▶ to scroll through information regarding current and upcoming program.

Press ▲ or ▼ to display the radio channel list. As in TV mode, you may create a list of favorites among the radio channels (see chapter 7.5, **Favorites**).

4.5.2 Categories and other options in radio mode

Each time you change the radio channel the program information bar appears. If you press the yellow button on your remote now, you can quickly reach the first channel of a particular category, for example **News** where categories are available for the program.

Press  to display detailed information about a program.

Press  to see more options, if available for the current radio program.

5 Setting a timer

Your Receiver has the ability to set timers for favorite programs in order to notify you in time before the start of the broadcast. The unit will automatically switch to that program before the program starts.

This feature is especially useful when you wish to record a video or DVD. Before recording a program on video or DVD make sure that:

- Your recorder is connected to the Receiver (see chapter 2.4, **Connection to the VCR / DVD recorder**)
- Your recorder is adjusted for the same period for recording as the Receiver
- The Receiver is not turned off at the time of the recording but turned on or in standby mode.

You can record TV and radio programs.

5.1 Set timer

A flag can be set for upcoming broadcasts (TV and radio). To set a flag for a program, you have to navigate to the program information bar in the digital program guide or to the search results. Once you have set a flag (see below), you can change the channel or put the Receiver into standby. Shortly before the scheduled broadcast a screen message is displayed that the Receiver will switch to the remembered program.

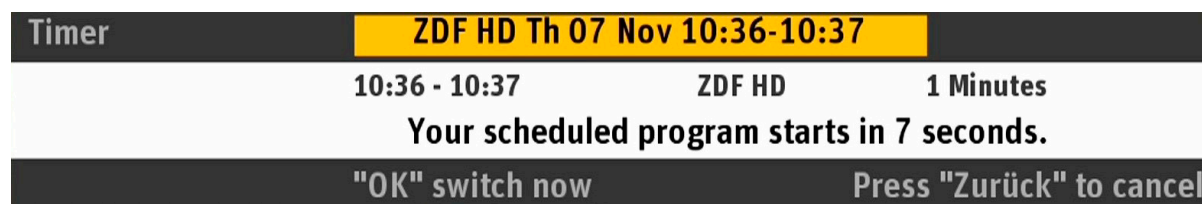

By default, the Receiver switches to the respective program before the program begins. After the end of the program, the Receiver returns to the channel previously selected.

Note: If you want to record a flagged program on your VCR or DVD recorder, these devices must be set at the scheduled time to record.

5.1.1 Set flags in program information bar

1. Press or one of the keys ▲, ▼, ◀, ▶ to enter the program information bar.
2. Use ◀, ▶ to browse to the program you wish to record. Press to set a timer for a program. The program information window opens.
3. Use ▲, ▼ to select **Set timer** and press . See chapter 4.1.2, **Program information bar** for more information.

5.1.2 Set timer in electronic program guide (EPG)

1. Press to switch to the EPG.
2. Use ▲, ▼, ◀, ▶ to navigate to the selected program in the EPG. Press to set a timer for a program. The program information window opens.
3. Use ▲, ▼ to select **Set timer** and press . See chapter 6.1, **Electronic Program Guide (EPG)** for more information.

5.1.3 Set timer in search results

1. Press to enter search, perform a search for keywords or categories as described in chapter 6.2.
2. Use **▲**, **▼**, **◀**, **▶** to navigate to the selected program in the search results. Press to set a timer for a program. The program information window opens.
3. Use **▲**, **▼** to select **Set timer** and press . See chapter 4.1.2, **Program information bar** for more information.
 - The selected program is marked in grey in the program information bar and in the EPG.
 - If the saved program overlaps with another saved program, you will be prompted to correct the overlap.

If a program is not approved for minors, the Receiver asks you to enter the Parental Control PIN to confirm the timer.

5.1.4 Delete timer

1. In the program information bar, in the EPG or in search use the keys **▲**, **▼**, **◀**, **▶** to select a program.
2. Press . The program information window opens.
3. Use **▲**, **▼** to select **Cancel timer** and press .

5.2 Set timer manually

To set a timer for a program, the Receiver automatically retrieves the data required for the selected program and stores it.

If too few details for the program are available, the Receiver offers to set the details of the recording manually.

Additionally, you can also prepare a timer manually for a period of your choice on a channel you select.

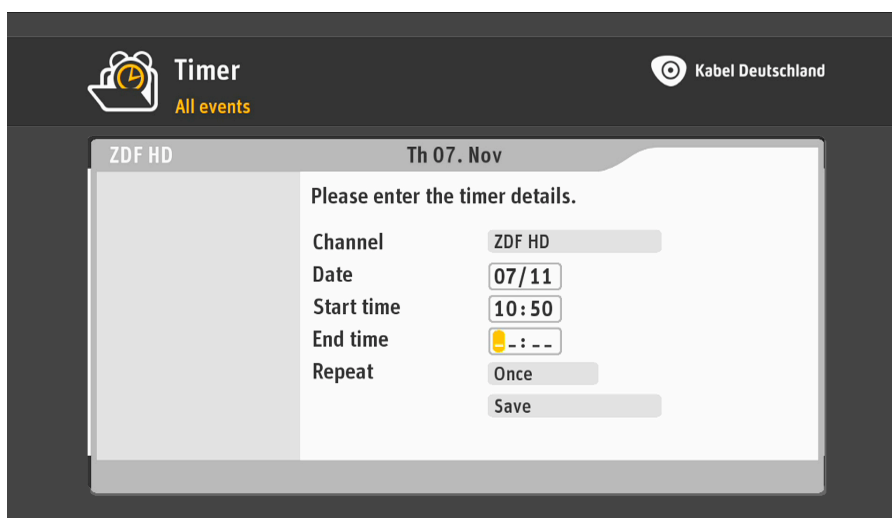

Press on your remote and use the keys **▲**, **▼** and to choose **Settings, Timer, Set timer**.



Now choose your settings:

1. Choose a channel. Use **▲**, **▼** to select **Channel**. In the list use **▲**, **▼** to select a channel and confirm

your choice by pressing .

2. Select a date. Use **▲**, **▼** to select **Date**. Use the number keys of your remote to choose a date.
3. Enter the start and end time of the timer. Press **▲**, **▼** to select **Start time**. The marker automatically jumps to the line **End time**. Use the number buttons on your remote to insert the end time.
4. Select whether the recording should take place once or repeatedly. The marker jumps automatically to the line **Repeat**. By default **Once** is set. To set an automatic repetition of the recording, press . Now select how often you want the recording to take place:
 - **Once**: once at the set time.
 - **Daily**: every day at the set time.
 - **Mon-Fri only**: every week day from Monday to Friday at the set time.
 - **Weekly**: at an interval of seven days from the date set for the set time.
5. Use **▲**, **▼** to select **Save** and press .

The manually prepared timers in the timer list will show a clock symbol. The manually prepared recurring timers are stored in a folder that is named with the channel's name and date and time of the recording.



Manual programmings can always be changed via the menu **Timer**.

Note

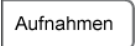

You can customise your timer settings to add extra time before and after your manual timers (see chapter 7.4.2, **Timer extensions**).

5.3 Displaying and using timers

Press  on your remote to open **Timer**. Or press  and use **▼** and  on your remote to select **Timer**.

For details concerning your timers and folders choose the referring line using the keys **▲**, **▼** and press . All timers are shown in **Timer**.

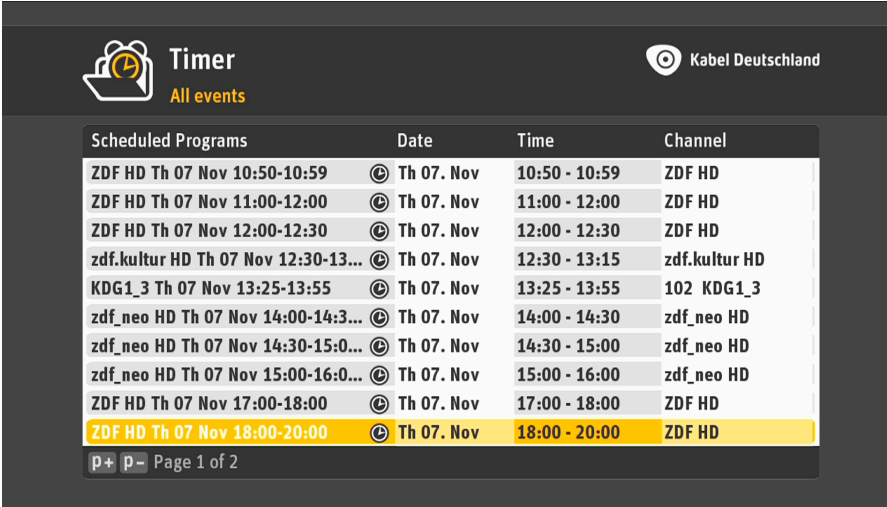

The screenshot shows the 'Timer' menu with a list of scheduled programs. The menu title is 'Timer' with a clock icon and 'All events' below it. The top right corner shows the 'Kabel Deutschland' logo. The list has four columns: 'Scheduled Programs', 'Date', 'Time', and 'Channel'. The last row is highlighted in yellow.





Scheduled Programs	Date	Time	Channel
ZDF HD Th 07 Nov 10:50-10:59	⌚ Th 07. Nov	10:50 - 10:59	ZDF HD
ZDF HD Th 07 Nov 11:00-12:00	⌚ Th 07. Nov	11:00 - 12:00	ZDF HD
ZDF HD Th 07 Nov 12:00-12:30	⌚ Th 07. Nov	12:00 - 12:30	ZDF HD
zdf.kultur HD Th 07 Nov 12:30-13:15	⌚ Th 07. Nov	12:30 - 13:15	zdf.kultur HD
KDG1_3 Th 07 Nov 13:25-13:55	⌚ Th 07. Nov	13:25 - 13:55	102 KDG1_3
zdf_neo HD Th 07 Nov 14:00-14:30	⌚ Th 07. Nov	14:00 - 14:30	zdf_neo HD
zdf_neo HD Th 07 Nov 14:30-15:00	⌚ Th 07. Nov	14:30 - 15:00	zdf_neo HD
zdf_neo HD Th 07 Nov 15:00-16:00	⌚ Th 07. Nov	15:00 - 16:00	zdf_neo HD
ZDF HD Th 07 Nov 17:00-18:00	⌚ Th 07. Nov	17:00 - 18:00	ZDF HD
ZDF HD Th 07 Nov 18:00-20:00	⌚ Th 07. Nov	18:00 - 20:00	ZDF HD

At the bottom left of the list, there are navigation buttons: 'p+', 'p-', and 'Page 1 of 2'.

In **Timer** first all folders for series are displayed, followed by the timers created manually and the timers for individual programs. For each line, the following properties are displayed:

- Folder or program name
- Start date of timer
- Time of broadcast
- Channel name or number

Use the following icons to quickly realize which kind of timers are displayed:

Symbol	Description
	The folder contains timers with repetition scheme: <ul style="list-style-type: none">• A series whose future sequences are timed automatically.• Manual timers with repetition scheme.
	The folder contains timers without repetition scheme: <ul style="list-style-type: none">• A series which is terminated.• A series with deleted timers.
	The timer was prepared manually.
	The folder was prepared manually.
	PIN protected timers. To lock / unlock an item select it using the keys ▲, ▼, press <input type="button" value="Info"/> and select an action.

To leave **Timer** press .



6 Electronic program guide (EPG), search function and Select Video (video library)

If you are looking for programs that interest you, press  on your remote. Now you see the following options:

- **Program Guide:** The electronic program guide (EPG) provides an overview of current and upcoming programs.
- **Search:** Searches current and upcoming programs by genre and titles that you enter.
- **Select Video:** Access to the online video Select Video to download a film or broadcast on your Receiver.

6.1 Electronic Program Guide (EPG)

The digital program guide, also known as EPG, offers a preview for most TV and radio channels. You can set a timer directly from the EPG, see chapter 5.1.2, **Set timer in electronic program guide (EPG)**. The EPG previews up to 7 days, depending on the channel.

Press  on your remote control to open the EPG. Or press  and select **Program Guide** using the key ▼ and press  on your remote control.







You can choose to view the digital program guide for the TV or the radio program. To switch between TV and radio press  on your remote.





A	You receive an information on the specific day that is displayed.	C	The period in which the programs are broadcasted. The current period is highlighted with a fine yellow timeline.
B	You receive an information on the specific channels that are displayed. If you select a channel, it is highlighted in yellow, the other channels are gray.	D	Here you can see the broadcasts of the respective channel (list on the left) for the relevant period (time axis above).

For better orientation, the EPG marks the current time with a yellow timeline.

How to use the EPG:

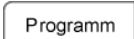
- To select a program or a channel on the current page of the digital program guide press the keys ▲, ▼, ◀, ▶ on your remote. Looking for a specific channel and knowing the number of the channel in your favorites? Then you can also enter this number directly using the number buttons on your remote control.
- To browse the EPG, press **P+** (one page forward) and **P-** (one page back) on your remote control.
- To move to the next day, press . To move to the previous day, press .
- To view details such as content or performer of a program, select the title of the program with one of the keys ▲, ▼, ◀, ▶ on your remote. As soon as the title of the program appears in yellow, press .
- Do you want to leave the digital program guide and watch the program that you selected using the keys ▲, ▼, ◀, ▶ on your remote? Press .
- Do you want to see programs shown in prime time on the same day from 8 pm? Press .
- Do you want a preview exclusively for a particular channel category (e.g. sports)? Simply press the yellow button on your remote control. Select a category using the keys ▲, ▼ on your remote and press .
- To set a timer for an upcoming program, select it by pressing the keys ▲, ▼, ◀, ▶ and press . For more information see chapter 5.1.2, **Set timer in electronic program guide (EPG)**.

To exit the EPG press  or  on your remote.

6.2 Search

With the search function you can search for any keyword. For example actors, movie titles or different keywords but also by categories such as movies, series, entertainment, etc.

An internet connection is required for using all features within the search function. The results do not only include television broadcasts from the EPG but also the movies of online video library Select Video, if available in your region.

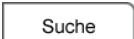
Press  on your remote to begin the search.

You can also press  on your remote control and then use the four keys ▲, ▼, ◀, ▶ to select **Search**.

You are automatically in the keyword search.

6.2.1 Search by keyword

Enter a keyword on the on-screen keyboard:

- Select the characters using the four keys ▲, ▼, ◀, ▶ and press  for each character you want to

select.

Note



You may enter numbers using on the on-screen keyboard as well as using the number buttons on your remote control.

After entering the third letter, the search will start automatically and search results that contain the letters you type.

The list on the right contains results that include your keyword. In the list you find results from the current television program and from the film supply of Select Video.

By pressing ► on your remote you can now switch to the right window into search results. If you want detailed information about this result, use the keys ▲, ▼ to select the search result and press . If you selected a movie title with the arrow keys press . The time of the broadcast is displayed now. If your keyword is an actor name, films with this actor will now display, including broadcast date and channel.

To select a TV program or a rental video from the list press and follow the instructions on the screen navigating with the four keys ▲, ▼, ◀, ▶ and confirming with .

Possibly the list of results has multiple pages. If necessary, move to the next page using ▲ and return to the last page pressing ▼.

If you are in the keyword list, you may wish to refine your search. To do this, press ► to proceed to the search filters. The filters **Search for keyword**, **Search for title only**, **Search for person only** refine your search. In this case, the search only displays results according to the chosen filter. Use ◀ to move from the list of filters back to the refined search results.

6.2.2 Search by category

In addition, you also have the opportunity to search by category such as programs in a particular category (eg, movie or sport).

1. Select **Category** using ◀, ▶ and press or ▼.
2. Select a category from the list using ▼, ▲ and press or ▶.
3. For some categories more input is needed. E.g. if you select **Spielfilm** as category, another list is displayed in which a subset should be selected, such as **Action**, **Comedy**, **Krimi** etc. Select a subcategory from the list with the ▼, ▲ keys and press .
4. If you want to refine your search, press ► to proceed to the search filters. Filters like **Show all**, **Show TV only** refine your search. In this case only results according to the chosen filter are displayed. Select a filter from the list with the ▼, ▲ keys and press .

Note



Possibly the list of categories has multiple pages. If necessary, move to the next page using P+ on your remote and return to the last page pressing P-.

6.2.3 Search results

In the list of search results all matching programs are displayed with date, time and channel.



How to use the search results:

- Browse the list of results using ▲, ▼ on your remote.
- To browse several pages of a results list press **P+** (one page forward) and **P-** (one page back) on your remote.
- To display details like content or actors select the title of the program using the keys ▲, ▼, ◀, ▶. If the title is marked yellow, press **OK**.
- To set a timer for a current program or prepare a timer, select it using ▲, ▼, ◀, ▶ and press **Rec** as soon as the title is marked yellow.

For more information on this feature, see chapter 5, **Setting a timer**.

To leave the search press **Suche** or **Exit** on your remote.

6.2.4 Local Search

If you have not established an internet connection you can use the local search. Press **Suche** on your remote to start the search. You can also press **Menü** on your remote control and then use the four keys ▲, ▼, ◀, ▶ to select **Search**.

Press ▼, select **Search without internet connection** and press **OK**.

6.2.4.1 Title/Actor

You can search for a program by entering the title or the actor name.

- On the Enter keyword tab, select at least three characters by using the four keys ▲, ▼, ◀, ▶ and the **OK** button on the virtual keyboard.
- Select the **List** entry on-screen to move to the list of keywords matching to the entered title/actor. If there are no titles or actors listed, the list is disabled.

6.2.4.2 Categories

You can search for a program by category.

- Select **Category** and press **OK** or ▶ button.

- For some categories more input is needed. E.g. if you select Spielfilm as category, another list is displayed in which a subset should be selected, such as Action, Comedy, Krimi etc.
- Press to view search results.

6.3 Select Video (online video library)

Select Video is a video-on-demand service (VOD). It offers videos on demand through the internet and in high diversity. You order and play rental videos via your Receiver, if it is connected to the internet.

6.3.1 Access to Select Video

Select Video is only available if the service is available in your region and you are entitled to. In addition, you have to connect the Receiver to the internet via your router in order to use all features of Select Video (see chapter 7.2.5, **Internet**).

6.3.2 Selection of videos

Press on your remote to enter the online video store. Alternatively press , select **Select Video** using the key ▼ and press .

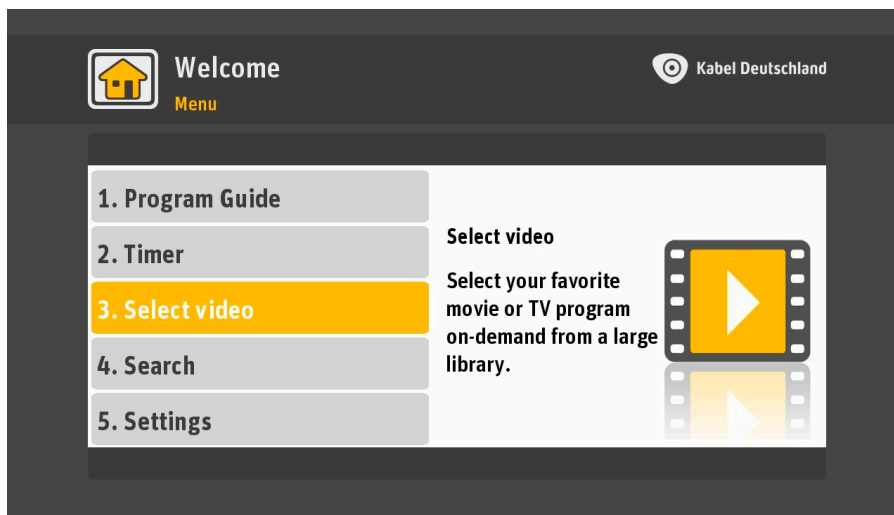

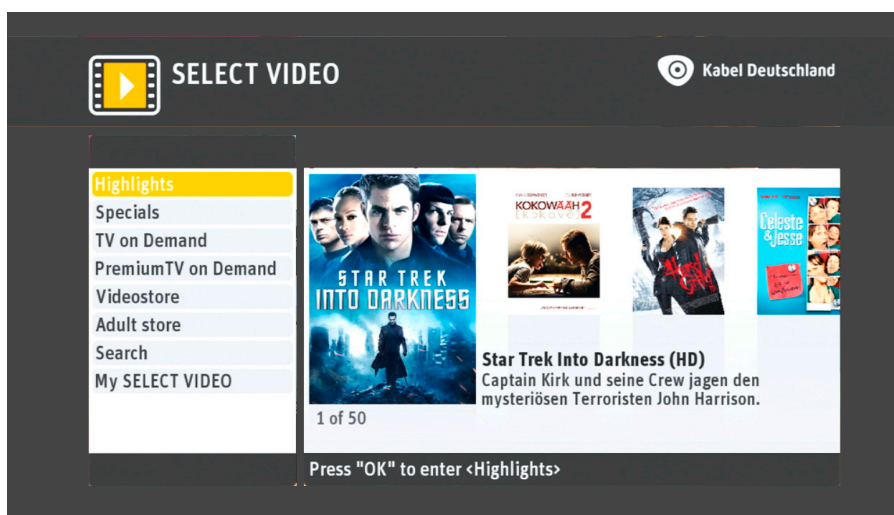

You will see a list of several categories such as **Highlights**, **Specials**, **TV auf Abruf** etc. Use the keys ▲, ▼ to select a category and press .



You will now see the available films or programs in this category. Use the arrow keys to select a movie or a show. Select a film or a program using ◀, ▶. If the item is marked yellow, press . Follow the instructions on the screen. Navigate using ▲, ▼, ◀, ▶ and confirm your selection with .



7 Settings

Press  on your remote. Select **Settings** using the keys ▲, ▼. Press . Select one of the following options using the keys ▲, ▼:

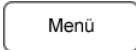

1. **System update**
2. **System set-up**
3. **Parental control**
4. **Timer**
5. **Favorites**
6. **Service**
7. **System check**

7.1 System Update

Using the settings in **System update** you can configure the software update feature, search for channels, add or remove channels, and reset the Receiver to factory default.

Press  on your remote. Use the keys ▲, ▼ to select **Settings**. Press . Select **System update** with the keys ▲, ▼:

To return to the previous screen and save your changes, press  or ◀.





To exit the menu screen, press  or .

7.1.1 Software update

You can choose two types of software updates, the two available options are **Automatic** and **Manual**. **Manual** is the default.

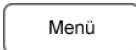
If **Automatic** is selected, the Receiver automatically updates its operating software at intervals when it is in standby mode. If **Manual** is selected, you will be prompted to perform the upgrade immediately when a software update is available, or wait until the Receiver is in standby mode or otherwise to refuse.

To change this setting:

1. Press  on your remote. Use the keys ▲, ▼ to select **Settings**. Press .
2. Use the keys ▲, ▼ to select **System update**. Press  or ▶.
3. Use the keys ▲, ▼ to select **Software update mode**. Press  or ▶.
4. Use the keys ▲, ▼ to select how the software should be updated: **Automatic** or **Manual**.
5. Press  to confirm the new setting.

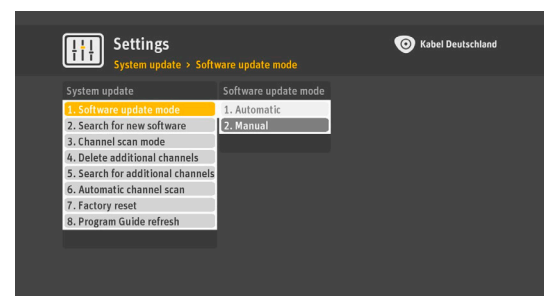

More information on software updates can be found in see chapter 8, **Software update**.

7.1.2 Search for updated software

You can search for new operating software for your Receiver at any time. This feature is especially useful

if you have previously rejected an update that you want to catch up now.

To start a search for new software:

1. Press on your remote. Use the keys ▲, ▼ to select **Settings**. Press .
2. Use the keys ▲, ▼ to select **System update**. Press or ►.
3. Use the keys ▲, ▼ to select **Search for new software**. Press or ►.
4. The Receiver will search for new software.
5. If new software is available, use the keys ▲, ▼ to select one of the following options: **Download it now**, **In Standby** or **Do not download**. Press .

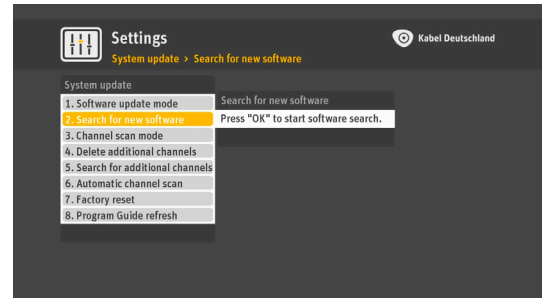

More information on software updates can be found in see chapter 8, **Software update**.

7.1.3 Channel search

Per default the Receiver automatically checks at intervals if new channels are available, and stores them when it is in standby mode.

You can choose two types of channel search, the two available options are **Automatic** and **Manual**. **Automatic** is the default.

If **Automatic** is selected, the Receiver automatically updates its channels list at intervals when it is in standby mode. As soon as an update of the channel list is available you will be prompted to perform the update immediately, to wait until the Receiver is in standby mode or otherwise to refuse, if **Manual** is selected.

To change the setting:

1. Press on your remote. Use the keys ▲, ▼ to select **Settings**. Press .
2. Use the keys ▲, ▼ to select **System update**. Press or ►.
3. Use the keys ▲, ▼ to select **Channel scan mode**. Press or ►.
4. Use the keys ▲, ▼ to select, how the channel list should be updated: **Automatic** or **Manual**.
5. Press to confirm the new setting.

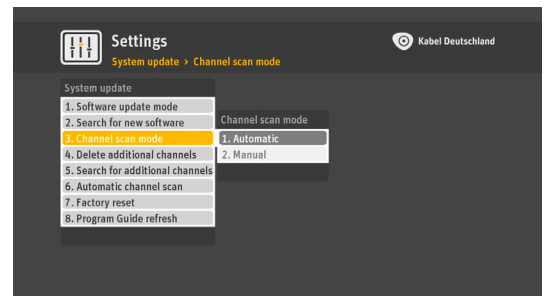

7.1.4 Delete additional channels

Use this feature to delete unwanted channels after performing a manual search (described in chapter 7.1.5, **Search additional channels**).

1. Press on your remote. Use the keys ▲, ▼ to select **Settings**. Press .
2. Use the keys ▲, ▼ to select **System update**. Press or ►.
3. Use the keys ▲, ▼ to select **Delete additional channels**. Press or ►.
4. Use the keys ▲, ▼ to select channels to be deleted and mark them. The list of additional channels may consist of multiple pages. To browse through the pages of the list press **P+** (forward) or Taste **P-** (back).
5. To undo the selection of a channel you selected press .
6. After selecting all channels to be deleted, press or ◀.

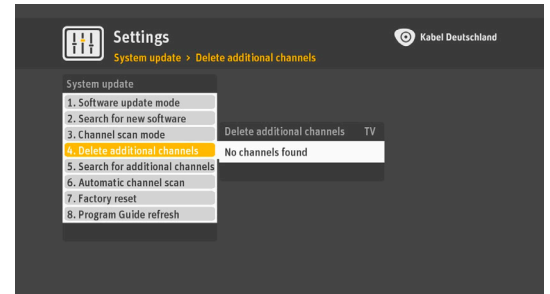

7.1.5 Search additional channels

This menu lets you search for additional channels manually by typing a specific cable frequency. Cable frequencies are available on the website of Kabel Deutschland or made available by your television channel.

To start the search for additional channels:

1. Press on your remote. Use the keys ▲, ▼ to select **Settings**. Press .
2. Use the keys ▲, ▼ to select **System update**. Press or ►.
3. Use the keys ▲, ▼ to select **Search for additional channels**. Press or ►.
4. Input a **Frequency** using the number keys of your remote. Press .
5. Use the keys ▲, ▼ to select **Search**. Press .
6. The Receiver searches for TV and radio channels and displays the number of channels found. To cancel the search press or .
7. Save the channels by pressing .

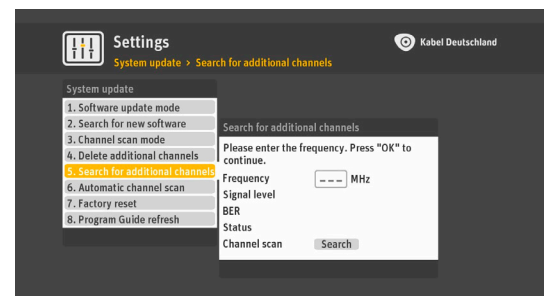

7.1.6 Start a channel search

Per default the Receiver automatically checks at intervals if new channels are available and saves them when it is in standby mode. You can start this search manually, if necessary. This feature is especially useful if you have previously rejected an update that you want to catch up now.

To start a channel search:

1. Press on your remote. Use the keys ▲, ▼ to select **Settings**. Press .
2. Use the keys ▲, ▼ to select **System update**. Press or ►.
3. Use the keys ▲, ▼ to select **Automatic channel scan**. Press .
4. The Receiver will scan for new TV channels and radio channels and show the number of channels found. You can stop the search by pressing or .
5. To save the channels press .

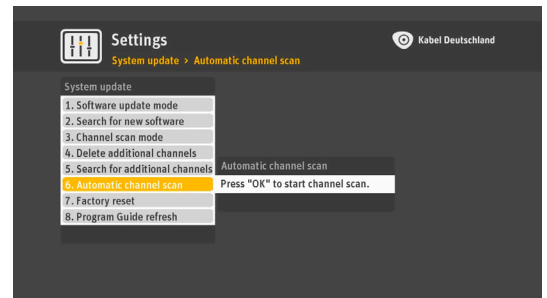

7.1.7 Reset to factory default

This menu lets you restore the factory settings of the Receiver.

Note



If you restore the factory settings, your favorites, settings and prepared timer are lost.

1. Press on your remote. Use the keys ▲, ▼ to select **Settings**. Press .
2. Use the keys ▲, ▼ to select **System update**. Press or ►.
3. Use the keys ▲, ▼ to select **Factory reset**. Press .
4. To cancel, use the keys ▲, ▼ to select **No**. Press or . To confirm, use the keys ▲, ▼ to select **Yes**. Press .
5. After resetting to factory default, the installation screen of the Receiver is displayed. Set up the Receiver again (see chapter 3, **Initial installation**).

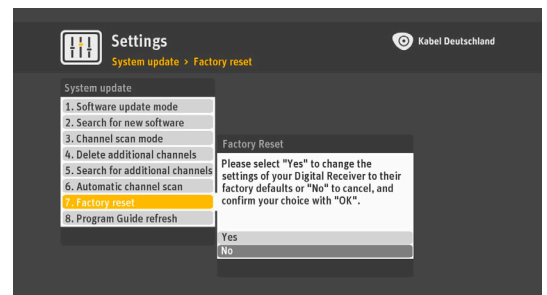

7.1.8 Update EPG

You can update the electronic program guide if necessary.

To start the update:

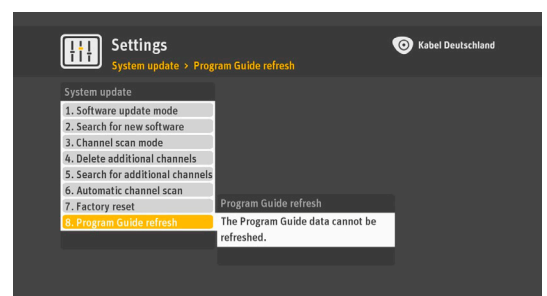

1. Press on your remote. Use the keys ▲, ▼ to select **Settings**. Press .
2. Use the keys ▲, ▼ to select **System update**. Press or ►.
3. Use the keys ▲, ▼ to select **Program Guide refresh**. Press .

The message **Program Guide refresh in progress...** is displayed.





7.2 System set-up

The **System set-up** menu allows you to change the settings for language, audio and picture, energy use as well as for the internet connection of the Receiver and to control the remote control app.

Press  on your remote. Use the keys ▲, ▼ to select **Settings**. Press . Use the keys ▲, ▼ to select **System set-up**. Press .





To return to the previous screen to save your changes, press  or ◀.

To exit the menu screen, press  or .

7.2.1 Language

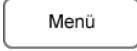
Using this setting you can configure the language settings for the user interface and the subtitle of the program. Broadcasts are also shown in the selected menu language, if available. The automatic (permanent) subtitle display can be enabled or disabled here.



To open the language settings:

1. Press  on your remote. Use the keys ▲, ▼ to select **Settings**. Press .
2. Use the keys ▲, ▼ to select **System set-up**. Press  or ▶.
3. Use the keys ▲, ▼ to select **Language**. Press  or ▶.



7.2.1.1 Menu language

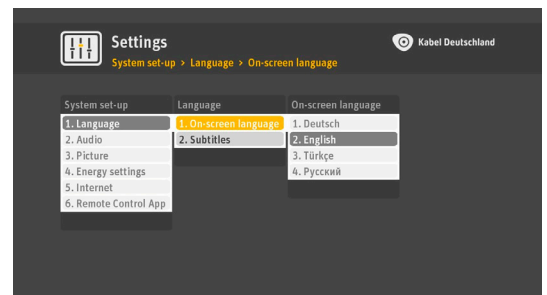

To set a default language for menus, sound and subtitles:

1. Use the keys ▲, ▼ to select **On Screen Language**. Press  or ▶.
2. Use the keys ▲, ▼ to select a language.
3. Press  to confirm.



7.2.1.2 Subtitles

To enable or disable automatic subtitle display:

1. Use the keys ▲, ▼ to select **Subtitles**. Press  or ▶.
2. Use the keys ▲, ▼ to select **On** (activate subtitles) or **Off** (disable subtitles).
3. Press  to confirm.

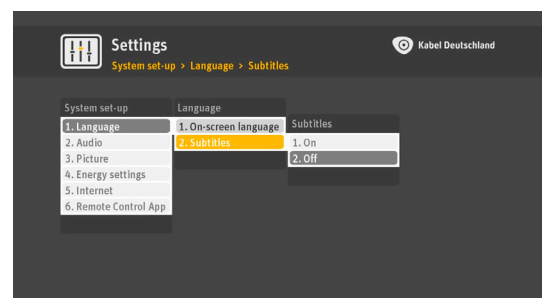

7.2.2 Audio

This menu lets you configure the following audio settings:

- **Audio Output:** Set the most appropriate AUDIO connector for your devices: **Mono** or **Stereo**.
- **Dolby Digital on HDMI / Dolby Digital on SPDIF:** You can activate or deactivate automatic playback of Dolby Digital at the HDMI connection for digital video / audio and the DIGITAL AUDIO jack (S / PDIF). In this case broadcasts are delivered in Dolby Digital if available. Refer to the manual of your audio system, which settings your device requires.

- **For visually impaired:** This audio is supplement with the sounds that aid to understand the action on the screen.

To open the audio settings:

1. Press on your remote. Use the keys ▲, ▼ to select **Settings**. Press .
2. Use the keys ▲, ▼ to select **System set-up**. Press or ►.
3. Use the keys ▲, ▼ to select **Audio**. Press or ►.

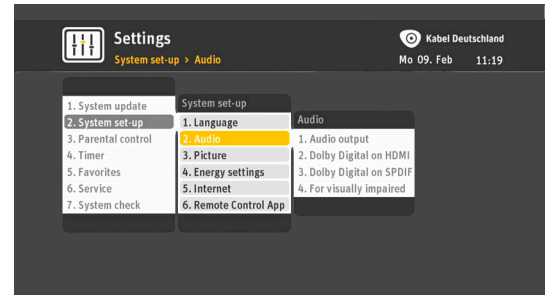

7.2.2.1 Audio output

To set the default settings for the audio output:

1. Use the keys ▲, ▼ to select **Audio output**. Press or ►.
2. Select the desired audio output. Use the keys ▲, ▼ to select **Mono** or **Stereo**.
3. Press to confirm.

7.2.2.2 Dolby Digital

To enable or disable Dolby Digital replay at the HDMI connection for digital video / audio and at the DIGITAL AUDIO connector (S / PDIF):

1. Use the keys ▲, ▼ to select **Dolby Digital on HDMI** or **Dolby Digital on SPDIF**. Press or ►.
2. Use the keys ▲, ▼ to select **On** (enable Dolby Digital) or **Off** (disable Dolby Digital).
3. Press to confirm.

7.2.2.3 For visually impaired

To enable or disable audio for visually impaired:

1. Use the keys ▲, ▼ to select **Audio**. Press or ►.
2. Use the keys ▲, ▼ to select **On** (enable audio for visually impaired) or **Off** (disable audio for visually impaired).
3. Press to confirm.

7.2.3 Picture

This menu lets you configure the following picture settings:

1. **TV-SCART / VCR SCART**
2. **SCART Switching**
3. **HDMI Screen Resolution**
4. **Banner Timeout**
5. **OSD-Transparency**
6. **Start Channel**

To open the image settings of the Receiver:

1. Press on your remote. Use the keys ▲, ▼ to select **Settings**. Press .
2. Use the keys ▲, ▼ to select **System set-up**. Press or ►.
3. Use the keys ▲, ▼ to select **Picture**. Press or ►.

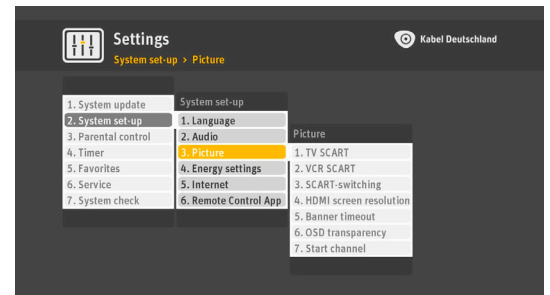

7.2.3.1 SCART settings for TV

Using this setting you can specify the most suitable video standard for TV output for the the TV connected to the TV SCART connector.

1. Use the keys ▲, ▼ to select **TV SCART**. Press or ►.
2. Set the video standard that is best suited for your TV. Refer to the manual of your TV for all necessary information. Use the keys ▲, ▼ to select **RGB**, **CVBS** or **S-Video**.
3. Press to confirm.

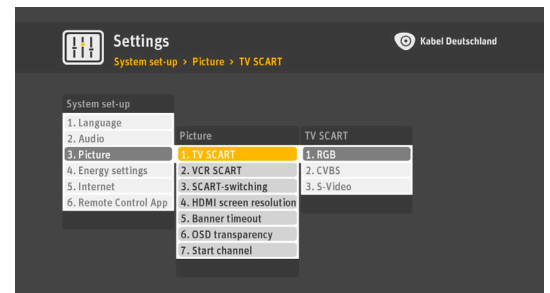

7.2.3.2 SCART settings for video recorder or DVD recorder

This menu lets you adjust the video standard that is best suited for the VCR or DVD recorder connected to the VCR SCART output.

1. Use the keys ▲, ▼ to select **VCR SCART**. Press or ►.
2. Set the video standard that is best suited for your device. Refer to the manual of your video recorder or DVD recorder for all necessary information. Use the keys ▲, ▼ to select **CVBS** or **S-Video**.
3. Press to confirm.

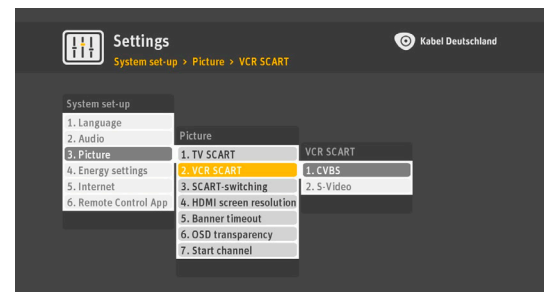

7.2.3.3 Video aspect ratio for SCART

This menu lets you select whether the video aspect ratio (4:3 or 16:9) is also automatically displayed on the TV SCART output.

1. Use the keys ▲, ▼ to select **SCART-switching**. Press or ►.
2. Use the keys ▲, ▼ to select **Always 16:9** or **Always 4:3**.
3. Press to confirm.

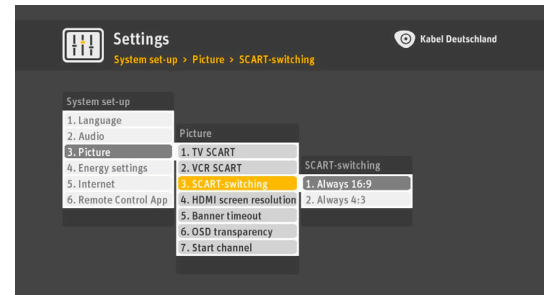

7.2.3.4 HDMI video resolution

Using this setting you can specify the output resolution for HDTV.

1. Use the keys ▲, ▼ to select **HDMI screen resolution**. Press or ►.
2. Determine the output resolution of your HD TV. Use the keys ▲, ▼ to select **576p**, **576i**, **720p** or **1080i**. If you use a standard TV, leave the setting to **720p**.
3. Press to confirm.
4. The Receiver will temporarily switch to the selected resolution. If you do not want to save this setting, use the keys ▲, ▼ to select **No**, press and select a different setting. If you want to save this setting, use the keys ▲, ▼ to select **Yes**.
5. Press to confirm.

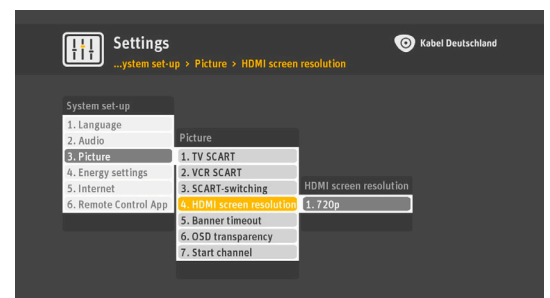

7.2.3.5 Display options for program information bar

Using this setting you can select how long the program information bar should be displayed on the TV screen (for more information see chapter 4.1.2, **Program information bar**).

1. Use the keys ▲, ▼ to select **Banner timeout**. Press or ►.
2. Use the keys ▲, ▼ to select **5 sec** or **10 sec**.
3. Press to confirm.

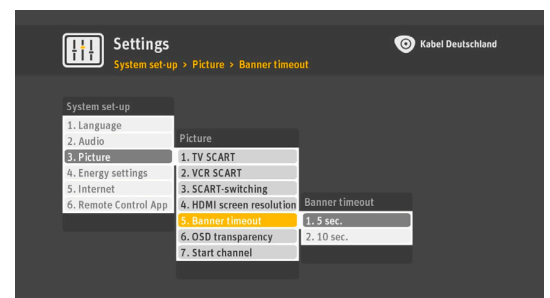

7.2.3.6 OSD Transparency

Using this setting you can select how transparent menus and messages in the so-called On-Screen Display (OSD) on the TV screen will be displayed.

1. Use the keys ▲, ▼ to select **OSD transparency**. Press or ►.
2. Use the keys ▲, ▼ to select **None** to disable OSD transparency. Use the keys ▲, ▼ to select **10%**, **30%** or **50%**, if you want to soften the image in the background to the respective percentage.
3. Press to confirm.

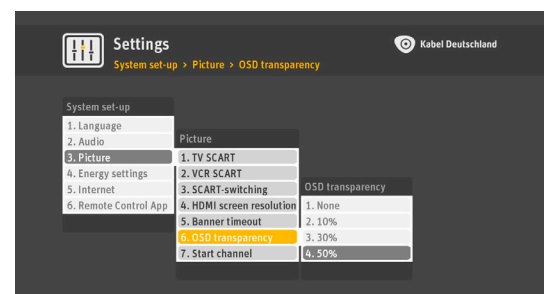

7.2.3.7 Startup channel

Select **On**, if the Receiver should always show the Kabel Deutschland channel on startup. Select **Off**, if the Receiver should always show the last viewed channel on startup.

1. Use the keys ▲, ▼ to select **Start channel**. Press or ►.
2. Use the keys ▲, ▼ to select **Off**, if the Receiver should always show the last viewed channel on startup. Use the keys ▲, ▼ to select **On**, if the Receiver should always show the Kabel Deutschland channel on startup.
3. Press to confirm.

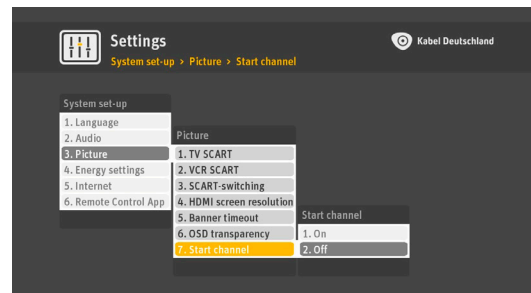

7.2.4 Energy settings

In this menu you decide whether your Receiver consumes less energy overall, but starts slowly, or if you wish a rapid operation of the Receiver, but want to take into account a higher overall energy consumption of the device. Select one of the modes: **Standard**, **Energy Save Mode**, **Quick Start** and **Active**. The default is the **Standard** mode, it causes the lowest power consumption and a longer start-up phase.

To change this setting:

1. Press on your remote. Use the keys ▲, ▼ to select **Settings**. Press .
2. Use the keys ▲, ▼ to select **System set-up**. Press or ►.
3. Use the keys ▲, ▼ to select **Energy settings**. Press or ►.
4. Use the keys ▲, ▼ to select **Standard**, **Energy Save Mode**, **Quick Start** or **Active**. Press . A description of the different modes is displayed.

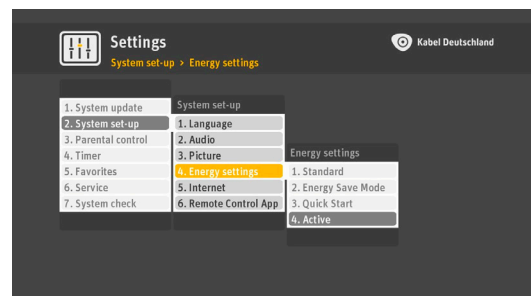

Standard: This mode helps you minimize your energy consumption. For this reason your Receiver takes longer to start and switches off automatically if the remote control is not used. The duration until automatic switch-off can be determined.







1. Use the keys ▲, ▼ to select **Standard**.
2. Press two times.
3. Use the keys ▲, ▼ to select the time in hours, until the device turns off automatically and press .
4. Use the key ▼ to select **Confirm** and press .

Energy Save Mode: In the Energy Save Mode your Receiver consumes little energy on standby. In contrast to the standard mode the Receiver does not switch off automatically.

1. Use the keys ▲, ▼ to select **Energy Save Mode**.
2. Press two times.

Quick start: In the quick start mode you can set on which days, at what time and for how long your Receiver automatically turns on from standby mode to active mode. The Receiver switches to active mode for the duration you determined.

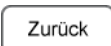
1. Use the keys ▲, ▼ to select **Quick start**.
2. Press .
3. Enter a start time using the number keys of your remote, for example **1 7 0 0** for 17:00 hrs (=5 p.m.).

4. Press  and use the keys ▲, ▼ to select, for how many hours the Receiver remains in the **Active** mode. Press .
5. Use the keys ▲, ▼ to select **Days**. Press .
6. Use the keys ▲, ▼ to select the days, on which the device remains in the **Active** mode during the time selected before. Press  for every day you wish to select.
7. Press  to save your settings.
8. Use the keys ▲, ▼ to select **Confirm** and press .

Active: In the Active Mode your Receiver is always available and boots within seconds. In this mode the device has the highest power consumption.

1. Use the keys ▲, ▼ to select **Active**.
2. Press  two times.

7.2.5 Internet

With an internet connection additional offers from Kabel Deutschland are available. To use them, you need to connect your Receiver to the internet, either through the wireless stick or via a network cable (LAN cable).

Note



Make sure that you have either the wireless stick connected via a USB port OR a LAN cable to the network port on the Receiver (see chapter 2.2, **Connection to TV**).







To set up an internet connection:

7.2.5.1 Setting up a wireless internet connection (Wi-fi)

Note



If the network does not appear in the list, you must configure it manually (see section **Setting up a wireless internet connection (Wi-fi) manually**, page 47).

1. Press  on your remote. Use the keys ▲, ▼ to select **Settings**. Press .
2. Use the keys ▲, ▼ to select **System set-up**. Press  or ►.
3. Use the keys ▲, ▼ to select **Internet**. Press  or ►.
4. Use the keys ▲, ▼ to select **Internet set-up**. Press .
5. Use the keys ▲, ▼ to select **Via the Kabel Deutschland wireless LAN-Stick** or **Via a LAN-cable**. Press .

Using the Kabel Deutschland WLAN-Stick

1. Use the keys ▲, ▼ to select **Via the Kabel Deutschland wireless LAN-Stick**. Press .

- Use the keys ▲, ▼ to select **Continue with security key for wireless LAN** or **Continue with WPS**.

Note



The wireless key is a string in the form of a password that protects access to your wireless internet access from unauthorized third parties. The wireless key is usually found in the documentation of your wireless router, the wireless access point to the internet. It is strongly discouraged to operate a wireless internet access in Germany without protection by a wireless key for reasons of data protection, data security and for legal liability.

You have additionally the option of selecting WPS. WPS stands for Wi-Fi Protected set-up and is another technology for establishing wireless connections, but with lower level safety.

Continue with wireless key

- Use the keys ▲, ▼ to select **Continue with security key for wireless LAN**. Press .
- The device now searches for available wireless networks. Use the keys ▲, ▼ to select the wireless network you would like to connect to. Press .
- Enter your wireless key.

Now an on-screen keyboard is displayed to type the WLAN key. The wireless key is usually between 8 and 63 characters long and can consist of numbers, letters and special characters. Usually you have to distinguish between lowercase and uppercase letters.

To enter the WLAN key, move the yellow highlight using the four keys ▲, ▼, ◀, ▶ on your remote control to the first character of the Wi-Fi key, and then press on your remote control. The character appears in the input line on the screen keyboard. Enter all characters of the wireless key. Use the **ABC** field in the screen keyboard and press on your remote to set the lowercase letters shown in the screen keyboard to uppercase if necessary. Use the field **!&?** in on the on-screen keyboard and press on your remote to display the special characters available. If the key is entered completely and correctly, finish the input via the field **Input ready** on the on-screen keyboard and press on your remote control.

- Now, the Receiver checks the network and internet connection. If the Receiver is connected to the internet, the message **The internet connection has been set up** appears. In addition, the LED light flashes on the wireless stick in the color orange.

Continue with WPS

- Use the keys ▲, ▼ to select **Continue with WPS**. Press .
- The device detects the internet connection and sets it up automatically. Press .

Note



For a WPS connection your router has to be prepared. The settings for a WPS connection have to be made in the software menu of your router. In addition, some routers ask for WPS activation on the router device itself.

Setting up a wireless internet connection (Wi-fi) manually

Use the manual configuration if your wireless network (Wi-fi) is not visible for security reasons, but allows devices to detect and register. To perform the manual configuration, keep the following information about the network ready: SSID network name, wireless security type and wireless key.

- Press on your remote. Use the keys ▲, ▼ to select **Settings**. Press .

2. Use the keys ▲, ▼ to select **System set-up**. Press or ►.
3. Use the keys ▲, ▼ to select **Internet**. Press or ►.
4. Use the keys ▲, ▼ to select **Internet set-up**. Press .
5. Use the keys ▲, ▼ to select **Via the Kabel Deutschland wireless LAN-Stick**. Press .
6. The screen for the network selection is displayed. Press to configure a wireless network (Wi-Fi) that is not visible for security reasons.
7. Use the keys ▲, ▼ to select **SSID**. Press .
8. Enter the name of the wireless network (also called SSID) on the on-screen keyboard. To enter the SSID, move the yellow highlight using the four keys ▲, ▼, ◀, ▶ on your remote control to the first character of the SSID, and then press on your remote control. The character appears in the input line on the screen keyboard. Enter all characters of the wireless key. Use the **ABC** field in the screen keyboard and press on your remote to set the lowercase letters shown in the screen keyboard to uppercase if necessary. Use the field **!&?** in on the on-screen keyboard and press on your remote to display the special characters available. If the key is entered completely and correctly, finish the input via the field **Input ready** on the on-screen keyboard and press on your remote control.
9. Select **Security Type**. Press . Select the type of security used on the network (**unsecured**, **WEP**, **WPA-PSK** or **WPA2-PSK**) using the keys ▲, ▼. Press .
10. Select **Security Key**. Press .

Now an on-screen keyboard is displayed to type the WLAN key. The wireless key is usually between 8 and 63 characters long and can consist of numbers, letters and special characters. Usually you have to distinguish between lowercase and uppercase letters.

To enter the WLAN key, move the yellow highlight using the four keys ▲, ▼, ◀, ▶ on your remote control to the first character of the Wi-Fi key, and then press on your remote control. The character appears in the input line on the screen keyboard. Enter all characters of the wireless key. Use the **ABC** field in the screen keyboard and press on your remote to set the lowercase letters shown in the screen keyboard to uppercase if necessary. Use the field **!&?** in on the on-screen keyboard and press on your remote to display the special characters available. If the key is entered completely and correctly, finish the input via the field **Input ready** on the on-screen keyboard and press on your remote control.

11. Use the keys ▲, ▼ to select **Save**. Press .

Setting up an internet connection via network cable (LAN cable)

1. Press on your remote. Use the keys ▲, ▼ to select **Settings**. Press .
2. Use the keys ▲, ▼ to select **System set-up**. Press or ►.
3. Use the keys ▲, ▼ to select **Internet**. Press or ►.
4. Use the keys ▲, ▼ to select **Internet set-up**. Press .

5. Use the keys ▲, ▼ to select **Via a LAN-cable**. Press .
6. The device detects the internet connection and sets it up automatically. Press .

7.2.5.2 Show internet connection settings

With this menu you can view the internet settings of the device.

1. Press on your remote. Use the keys ▲, ▼ to select **Settings**. Press .
2. Use the keys ▲, ▼ to select **System set-up**. Press or ►.
3. Use the keys ▲, ▼ to select **Internet**. Press or ►.
4. Use the keys ▲, ▼ to select **View settings**. Now the settings of the internet connections are displayed.

7.2.5.3 Test internet connection

In this menu you can test your internet connection.

1. Press on your remote. Use the keys ▲, ▼ to select **Settings**. Press .
2. Use the keys ▲, ▼ to select **System set-up**. Press or ►.
3. Use the keys ▲, ▼ to select **Internet**. Press or ►.
4. Use the keys ▲, ▼ to select **Test Connection**. Press .
5. The Receiver tests the connection and displays the result on the TV screen.

7.2.5.4 Disable internet connection

With this menu you can turn off the internet connection.

1. Press on your remote. Use the keys ▲, ▼ to select **Settings**. Press .
2. Use the keys ▲, ▼ to select **System set-up**. Press or ►.
3. Use the keys ▲, ▼ to select **Internet**. Press or ►.
4. Use the keys ▲, ▼ to select **Switch off**. Press . A message is displayed: **If you switch off now you will lose all functions using the internet connection. Most important examples are Video-on-Demand (if available) and Keyword Search.**
5. To turn off the connection press two times. To leave the connection turned on press .

7.2.5.5 Privacy

In this menu you can view the privacy information.

1. Press on your remote. Use the keys ▲, ▼ to select **Settings**. Press .
2. Use the keys ▲, ▼ to select **System set-up**. Press or ►.
3. Use the keys ▲, ▼ to select **Internet**. Press or ►.
4. Use the keys ▲, ▼ to select **Data privacy**. Press .
5. The privacy policy is displayed. Use **P+** and **P-** to browse. Press to leave this menu.

7.3 Protection of minors

With the **Parental control** menu you can change the PIN protection stored on your smartcard.

If you use the online video library Select Video, you can also:

- Change the Adult PIN
- Protect the purchase of Select Video with your Parental Control PIN

To return to the previous screen and save your changes, press or ◀.

To exit the menu screen press or .

7.3.1 Change Parental Control PIN

The Parental Control PIN is used to block access to channels and broadcasts, which are not suitable for minors. If you switch to channels or programs that are subject to the protection of minors the Receiver asks you to enter the Parental Control PIN. The broadcast will be played back after the correct Parental Control PIN has been entered.

Please note if you change the Parental Control PIN:

- The Parental Control PIN is a four digit code.
- You must first enter the current Parental Control PIN before changing.
- The current Parental Control PIN must match the PIN stored on the smartcard.
- The new Parental Control PIN must be different from the current PIN.
- The new Parental Control PIN must be different from the current Adult PIN, both must not be the same.
- The new PIN must not consist of the same four digits.
- If you enter the wrong PIN three times, access is blocked for ten minutes.

To change the Parental Control PIN:

1. Press on your remote. Use the keys ▲, ▼ to select **Settings**. Press .
2. Use the keys ▲, ▼ to select **Parental control**. Press or ▶.
3. Use the keys ▲, ▼ to select **Change PIN**. Press or ▶.
4. Enter the current four-digit Parental Control PIN using the number keys on the remote control.
5. Enter the new four-digit Parental Control PIN.
6. Enter the new four-digit Parental Control PIN again, to protect against typos. If the first and second input match, you will receive confirmation that the Parental Control PIN has been changed successfully.

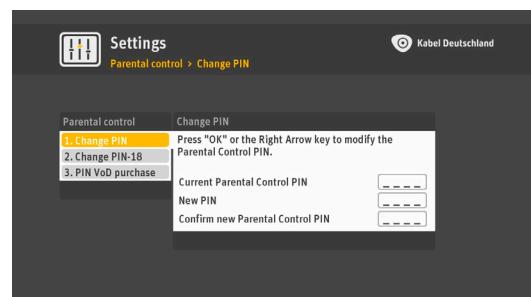

7.3.2 Change Adult PIN

The Adult PIN protects access to videos in the online video library Select Video, which are only suitable for adults. You can only change the Adult PIN if you use Select Video. Please note that the Adult PIN is always sent by mail and you may have to wait a few days until you can change the Adult PIN on your device.



Note



This function can only be used when the online video library Select Video is available at your address and if you are unlocked for the online video library Select Video.

Please note if you change the Adult PIN:

- The Adult PIN is a four digit code.
- You must first enter the current Adult PIN before changing.
- The current Adult PIN must match the Adult PIN stored.
- The new Adult PIN must be different from the current Adult PIN.
- The new Adult PIN must be different from the current Parental Control PIN, both must not be the same.
- The new Adult PIN must not consist of the same four digits.
- If you enter the wrong PIN three times, access is blocked for ten minutes.

1. Press  on your remote. Use the keys ▲, ▼ to select **Settings**. Press .

2. Use the keys ▲, ▼ to select **Parental control**. Press  or ►.

3. Use the keys ▲, ▼ to select **Change PIN-18**. Press  or ►.

4. Enter the current four-digit Adult PIN using the number keys on the remote control.

5. Enter the new four-digit Adult PIN.

6. Enter the new four-digit Adult PIN again, to protect against typos. If the first and second input match, you will receive confirmation that the Adult PIN has been changed successfully.

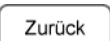
7. Press  to close the menu window.

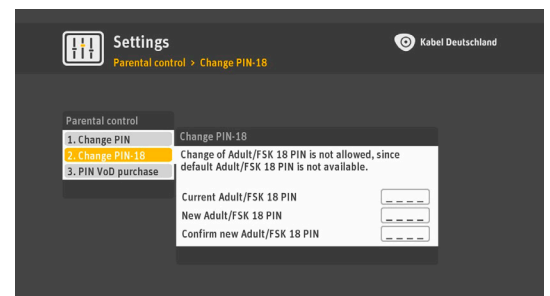

7.3.3 PIN request when ordering Select Video





With this setting, you can protect the order of paid programs in the online video library Select Video by first entering the Parental Control PIN. If this is selected, the Receiver prompts you to enter the Parental Control PIN as soon as you order a video in the online video library Select Video.

Note



This function can only be used when the online video library Select Video is available at your address and if you are unlocked for the online video library Select Video.



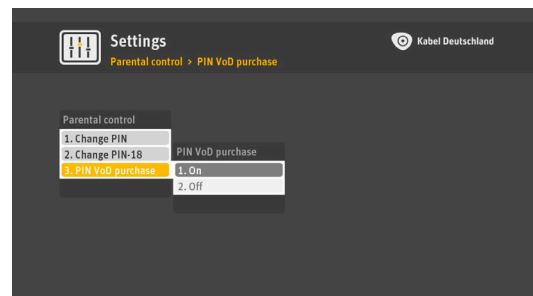

To set up PIN protection:

1. Press  on your remote. Use the keys ▲, ▼ to select **Settings**. Press .
2. Use the keys ▲, ▼ to select **Parental control**. Press  or ►.
3. Use the keys ▲, ▼ to select **PIN VOD purchase**. Press  or ►.
4. Use the keys ▲, ▼ to select **On** (PIN protection activated) or **Off** (PIN protection deactivated). If you select **On**, a window opens. Enter the current Parental Control PIN.
5. To turn off the Parental Control PIN protection, use the keys ▲, ▼ to select **Off**. A window opens. Enter the current Parental Control PIN.



7.3.4 PIN-protect timer

With this setting, you can protect access to your timer with the Parental Control PIN.

1. Press  on your remote. Use the keys ▲, ▼ to select **Settings**. Press .
2. Use the keys ▲, ▼ to select **Parental control**. Press  or ►.
3. Use the keys ▲, ▼ to select **PIN for timer**. Press  or ►.
4. Use the keys ▲, ▼ to select **On** (PIN protection activated) or **Off** (PIN protection deactivated). If you select **On**, a window opens. Enter the current Parental Control PIN.
5. To turn off the Parental Control PIN protection, use the keys ▲, ▼ to select **Off**. A window opens. Enter the current Parental Control PIN.

7.4 Timer settings



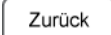

The menu **Timer** lets you prepare timers manually.

To return to the previous screen and to save your changes, press  or ◀.

To exit the menu screen, press  or .

7.4.1 Manual timer

This menu lets you program timers manually.

1. Press  on your remote. Use the keys ▲, ▼ to select **Settings**. Press .
2. Use the keys ▲, ▼ to select **Timer**. Press  or ►.
3. Use the keys ▲, ▼ to select **Set timer**. Press  or ►.
4. Set the timer options.

More information about timer functions can be found in chapter 5, **Setting a timer**.

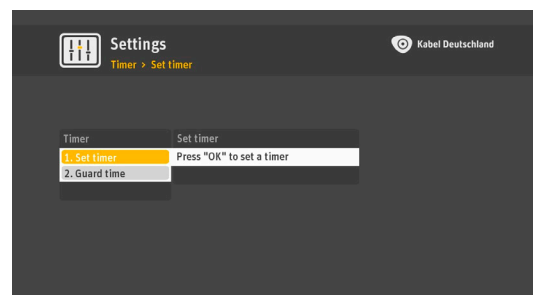

7.4.2 Timer extensions

In this menu you can set timer extensions that are automatically added to recordings from the EPG. It allows you to set the Receiver in a way that the timer begins before the announced starting time and ends after the announced end time.

You can program the following settings:

1. Press on your remote. Use the keys ▲, ▼ to select **Settings**. Press .
2. Use the keys ▲, ▼ to select **Timer**. Press or ►.
3. Use the keys ▲, ▼ to select **Guard time**. Press or ►.

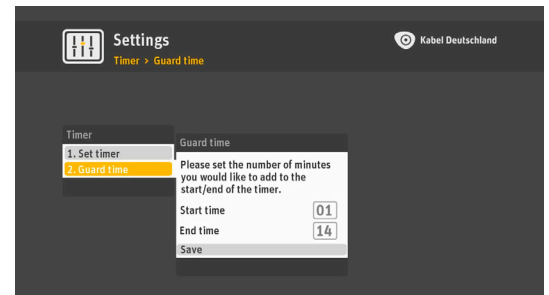

Note

In our example, the timer will start 1 minute before the start time and end 14 minutes after the end time of the broadcast. To choose the correct entries:



- For **Start time** enter the number of minutes using the number buttons on your remote control. Possible entries are all two-digit numbers from 00 to 99, e.g. 01.
- For **End time** enter the number of minutes using the number buttons on your remote control. Possible entries are all two-digit numbers from 00 to 99, e.g. 14.

4. Press to confirm the new setting.

7.5 Favorites

7.5.1 Add favorites

You can create two separate lists of favorites: for TV channels and radio channels.

1. Press on your remote. Use the keys ▲, ▼ to select **Settings**. Press .
2. Use the keys ▲, ▼ to select **Favorites**. Press or ►.
3. Use the keys ▲, ▼ to select **Add**. Press or ►.

Depending on the selected mode (radio or television), the list of TV channels or radio channels is displayed.

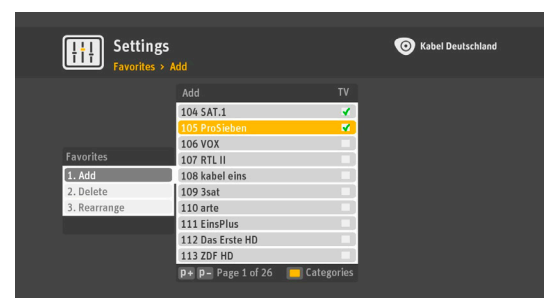

4. Press to specify which type of favorites list you want to create: TV channels or radio channels.
5. Select the channels you want to add as favorites. Use the keys ▲, ▼ to select them. Press for every channel you want to add. Selected channels are now marked.
6. To cancel your selection, press . To browse the list, press **P+** or **P-**.
7. Press or ◀. A confirmation message is displayed.
8. Press to save your favorites list.

7.5.2 Delete favorites

1. Press on your remote. Use the keys ▲, ▼ to select **Settings**. Press .
2. Use the keys ▲, ▼ to select **Favorites**. Press or ►.
3. Use the keys ▲, ▼ to select **Delete**. Press or ►.
4. Press to select the type of list you want to edit: TV or radio.
5. Select the channels you want to delete as favorites. Use the keys ▲, ▼ to select them. Press for every channel you want to delete. Selected channels are now marked.
6. To cancel your selection, press . To browse the list, press **P+** or **P-**.
7. Press or ◀. A confirmation message is displayed.
8. Press to save your changes.

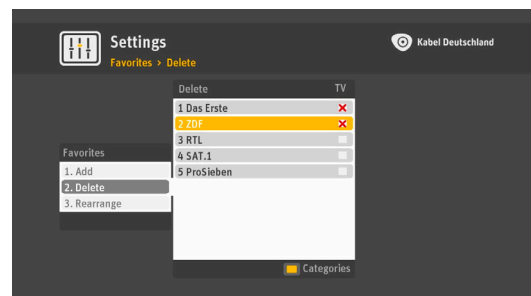

7.5.3 Sort favorites

With this setting you may rearrange your list.

1. Press on your remote. Use the keys ▲, ▼ to select **Settings**. Press .
2. Use the keys ▲, ▼ to select **Favorites**. Press or ►.
3. Use the keys ▲, ▼ to select **Rearrange**. Press or ►.
4. Press to select the type of list you want to edit: TV or radio.
5. Select the channels you want to move. Use the keys ▲, ▼ to select them.
6. Use the keys ▲, ▼ to move a channel by one position. Use the keys **P+** and **P-** to move a channel by ten positions. If a channel is in the right position, press .
7. Repeat the procedure for each channel you want to move.
8. Press or ◀. A confirmation message is displayed.
9. Press to save your changes.

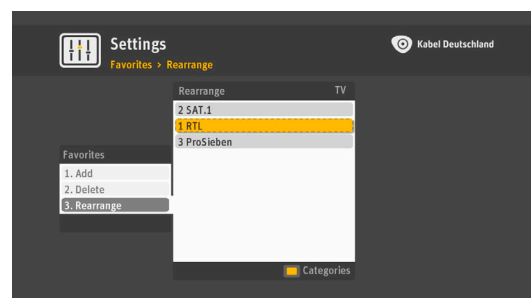

7.6 Service

7.6.1 Support by phone

In this menu you find a support number if you need assistance.

1. Press on your remote. Use the keys ▲, ▼ to select **Settings**. Press .
2. Use the keys ▲, ▼ to select **Service**. Press or ►.
3. Use the keys ▲, ▼ to select **Hotline list**.

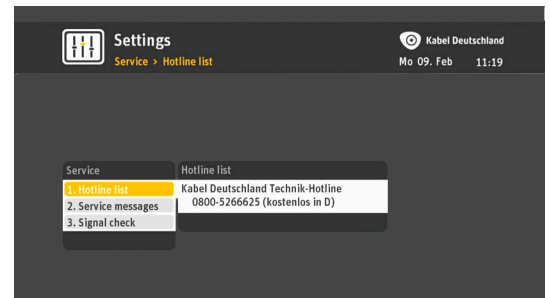

7.6.2 Service messages

Service messages are text messages that may be sent to you from the manufacturer. The menu **Service messages** gives you access to all the messages that have been sent to you, both read and unread.

1. Press on your remote. Use the keys ▲, ▼ to select **Settings**. Press .
2. Use the keys ▲, ▼ to select **Service**. Press or ►.
3. Use the keys ▲, ▼ to select **Service messages**. Press or ►.
4. To scroll the list of messages, press **P+** or **P-**.
5. Use the keys ▲, ▼ to select a message. Press to read it.
6. To save a message, use the keys ▲, ▼ to select **Close**. To delete a message, use the keys ▲, ▼ to select **Delete**.

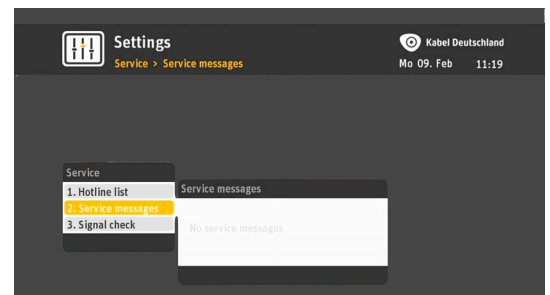

7.7 System Check

The information in these menus are particularly important in cases when you need to contact your cable operator or any other technical service.

Below you find information about the Receiver and its software, smartcard information, as well as a diagnostic program for the operating parameters of the Receiver.

To return to the previous screen and to save your changes, press or ◀.

To exit the menu screen, press or .



7.7.1 Device Info

This menu contains information on your Receiver.

1. Press on your remote. Use the keys ▲, ▼ to select **Settings**. Press .
2. Use the keys ▲, ▼ to select **System check**. Press or ►.
3. Use the keys ▲, ▼ to select **Device Info**, to look up the information on the device.



7.7.2 Smartcard

This menu contains information on your smartcard. To retrieve and display this information, the smartcard must be inserted into the Receiver.

1. Press  on your remote. Use the keys ▲, ▼ to select **Settings**. Press .
2. Use the keys ▲, ▼ to select **System check**. Press  or ►.
3. Use the keys ▲, ▼ to select **Smartcard**, to look up the information on the smartcard.

7.7.3 TV Signal

This menu contains information about your cable connection and provides an overview of the signal quality of cable frequencies.



1. Press  on your remote. Use the keys ▲, ▼ to select **Settings**. Press .
2. Use the keys ▲, ▼ to select **System check**. Press  or ►.
3. Use the keys ▲, ▼ to select **TV signal**, to look up the information on the TV signal.

The following network information is displayed:

- **Last channel scan:** Date of the last channel scan.
- **TV/radio channels:** Number of stored TV channels and radio channels.
- **Tuner parameter:** Displays the frequency and the modulation of the current channel for each tuner.
- **Signal level:** Displays the signal quality for each tuner to the current channel.
- **BER:** Displays the bit error rate of the current channel.
- **Network info:** Name of the cable network.



7.7.4 VOD Signal

With this setting you can check the video-on-demand (VOD) connection.

1. Press  on your remote. Use the keys ▲, ▼ to select **Settings**. Press .
2. Use the keys ▲, ▼ to select **System check**. Press  or ►.
3. Use the keys ▲, ▼ to select **VOD signal**, to look up the information on the VOD Signal.



7.7.5 HDMI

This menu contains information about a HD-TV connected to the Receiver via HDMI cable.

1. Press  on your remote. Use the keys ▲, ▼ to select **Settings**. Press .
2. Use the keys ▲, ▼ to select **System check**. Press  or ►.
3. Use the keys ▲, ▼ to select **HDMI**, to look up the information on HD-TV.



7.7.6 TV picture

This menu contains information about the current TV screen format and SCART equipment.

1. Press  on your remote. Use the keys ▲, ▼ to select **Settings**. Press .
2. Use the keys ▲, ▼ to select **System check**. Press  or ►.
3. Use the keys ▲, ▼ to select **TV picture**, to look up the information about the TV screen format and SCART equipment.



7.7.7 Audio

This menu contains information about the audio settings.

1. Press  on your remote. Use the keys ▲, ▼ to select **Settings**. Press .
2. Use the keys ▲, ▼ to select **System check**. Press  or ►.
3. Use the keys ▲, ▼ to select **Audio**, to look up the information about the audio settings.



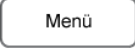

7.7.8 Network settings

This menu contains information about the internet connection via Wi-fi or network cable.

1. Press  on your remote. Use the keys ▲, ▼ to select **Settings**. Press .
2. Use the keys ▲, ▼ to select **System check**. Press  or ►.
3. Use the keys ▲, ▼ to select **LAN / WLAN**, to look up the information about the internet and network settings.





7.7.9 Back channel

With this setting, you can check the back channel connection.

1. Press  on your remote. Use the keys ▲, ▼ to select **Settings**. Press .
2. Use the keys ▲, ▼ to select **System check**. Press  or ►.
3. Use the keys ▲, ▼ to select **Back channel**, to look up the information about the return channel connection.
4. Press  to check the return channel. Now details are displayed.

7.7.10 Test IP Connection

With this setting you can check the speed of your internet connection.

1. Press  on your remote. Use the keys ▲, ▼ to select **Settings**. Press .
2. Use the keys ▲, ▼ to select **System check**. Press  or ►.
3. Use the keys ▲, ▼ to select **Test IP connection**, to look up the information about the speed of your internet connection.
4. . Press  to check the speed of your internet connection. Now the speed of your internet connection is displayed.

7.8 Settings overview

The following table shows an overview of the **Settings** menu and the default settings of the Receiver:

- Default settings are **bold**.
- Grey cells show that the sub menu prompts for an action, for editing or shows data that can not be changed.
- The asterisk (*) shows that the (sub) menu is only available when the Select Video service is enabled and if this service is available at your home port.

Menu	Sub-menu(s)	Default settings	#
System update			p. 37
	Software update mode	Automatic Manual	p. 37
	Search for new software		p. 37
	Channel scan mode	Automatic Manual	p. 38
	Delete additional channels		p. 39
	Search for additional channels		p. 39
	Automatic channel scan		p. 39
	Factory reset		p. 40
	Program guide refresh		p. 40
System set-up			p. 41
Language			p. 41
	On-screen language	Deutsch English Turkish Russian	
	Subtitles	On Off	
Audio			p. 41
	Audio output	Mono Stereo	
	Dolby Digital on HDMI	On Off	
	Dolby Digital on SPDIF	On Off	
	For visually impaired	On Off	
Picture			p. 43
	TV SCART	RGB CVBS S-Video	
	VCR SCART	CVBS S-Video	
	SCART switching	Always 16/9 Always 4/3	
	HDMI screen resolution	1080i 720p (if not detected on TV set) 576p 576i	
	Banner timeout	5 sec 10 sec	
	OSD transparency	None 10% 30% 50%	
	Start channel	On Off	

Menu	Sub-menu(s)	Default settings	#
	Energy saving mode	On Off	p. 45
	Standard		
	Energy save mode		
	Quick start		
	Active		
	Internet (*)		p. 46
	Internet set-up		
	View settings		
	Test connection		
	Switch off		
	Data privacy		
Parental control			p. 50
	Change Parental Control PIN		
	Change Adult PIN		
	PIN for VOD	On Off	
Timer			p. 52
	Set timer		
	Guard time	Automatic Manual If set to Automatic: <ul style="list-style-type: none"> • Start guard time: 1 min. • End guard time: 14 min. 	
Favorites			p. 53
	Add		
	Delete		
	Rearrange		
Service			p. 55
	Hotline list		p. 55
	Service messages		p. 55
System check			p. 55
	Device Information		p. 55

Menu	Sub-menu(s)	Default settings	#
	Manufacturer Model Serial number CA Serial number Hardware version Software version Last SW update Last SW update status Provisioning code Free space		
	Smartcard		p. 56
	Smartcard serial No. Smartcard version Smartcard status Program data status Program data version Program guide update Status program guide CA project name CAK version Chip NUID		
	TV signal		p. 56
	Last channel scan TV channels radio channels Tuner parameter Signal level BER Network		
	VOD signal		p. 56
	HDMI		p. 56

Menu	Sub-menu(s)	Default settings	#	
	HDMI screen resolution			
	HDMI status			
	HDCP status			
	TV manufacturer			
	TV model			
	TV picture			p. 56
		Selected channel		
		Picture mode		
		TV SCART		
		VCR SCART		
		SCART switching		
	Audio			p. 56
		On-screen language		
		Subtitles		
		Audio output		
		Dolby Digital on HDMI		
		Dolby Digital on SPDIF		
		For visually impaired		
	LAN / WLAN			p. 57
	WLAN / LAN IP address			
	Subnet mask			
	Default gateway			
	DNS server			
	LAN MAC address			
	Connection uptime			
	SSID			
	WLAN encryption			
	WLAN MAC address			
	Signal strength			
Back channel			p. 57	
Test IP connection			p. 57	

8 Software update

By default, the Receiver is in manual mode. The Receiver automatically checks for new software in the cable network. If an software update is available you can directly start the update, postpone until next standby mode or reject.

Using the menu **Settings, System update, Search for new software** you can start an automatic search for new Receiver software at any time (see chapter 7.1.1, **Software update**). If you change the update settings, the Receiver asks if you wish to perform the upgrade immediately, wait for the next switch to standby mode or to reject it.

In manual mode, when a new software update is available an alert is displayed:

- To accept the update, use the keys ▲, ▼ to select **Yes (Upgrade now)**. Press . The Receiver starts an update. You can use the Receiver only after successful completion of the update:
 - The progress of the update is displayed in the status screen.

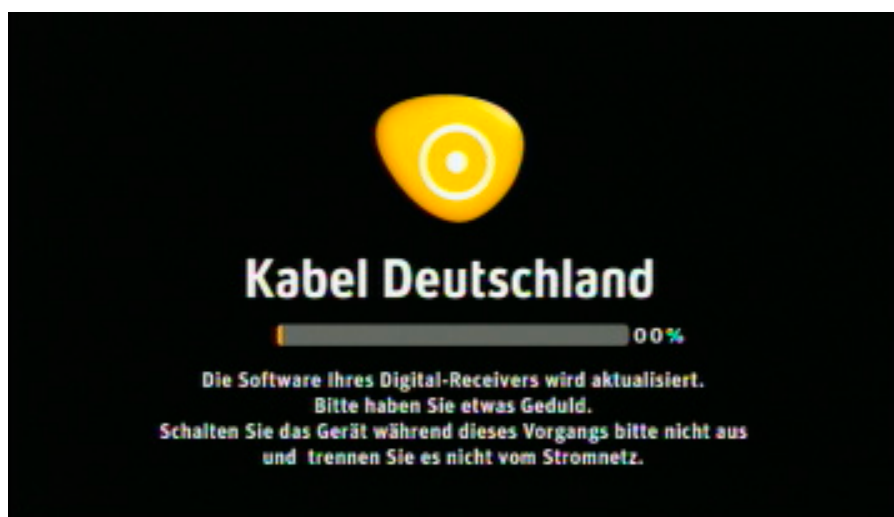

- After the update, the Receiver automatically switches back to the previously viewed program.
- To update in standby mode, use the keys ▲, ▼ to select **No (Wait for Standby)**. Press . The Receiver will update the software next time it switches to standby mode.
- To reject the update, use the keys ▲, ▼ to select **No (Do not upgrade at all)**. Press . The Receiver will not update the software.

Note









Please note, that you may not be able to use technical developments or additional services, if you reject a software update.

9 Universal remote control

The remote control is a universal model. You can program it to control your TV as well. The supported devices are listed in the Brand Code List.

After programing the remote use press  to switch from Receiver mode to TV mode. The LED flashes once in short interval. The LED also flashes after each command is transmitted to the TV.





These are the main controls for the direct control of your television:

- Standby/Wake up
- Volume up / down, mute
- Changing channels, keys **P+** and **P-**
- Four arrow keys , , , , 
- Access to the TV menu, key 

Press  to return to Receiver mode.

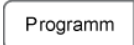

9.1 Programing the universal remote control



Refer to the brand code list for the right four-digit code for your TV.

1. Turn on your TV.
2. Press  and  at the same time for at least 3 seconds, until the LED on the remote flashes two times.
3. Enter the 4-digit code for your TV or the universal code. Make sure that not more than 10 seconds pass between the entry of each number. After entering the first 3 digits the LED flashes one time in short interval. After the fourth digit the LED flashes 2 times short and then remains lit.
4. Press  until your TV turns off.
5. Release the  key.
6. Press  for 3 seconds to confirm the code.
7. Press  to use your TV.

If you do not see your TV in the code list, please enter the code "0000" in step 3 and keep  pressed until your TV turns off. The remote control now starts a search through all the available codes. This process may take some time.





9.2 Selection of the volume control

When a TV code is programmed into the remote, the remote controls the volume of the TV also in Receiver mode (instead of the Receiver's volume). To change, press  and  at the same time for at least 3 seconds. The LED on your remote flashes 2 times.



To switch back to TV control mode, keep  and  pressed at the same time for at least 3 seconds. The LED on your remote flashes 2 times.

9.3 Reading out the 4-digit code

Using this method, you can read out the 4-digit code stored in the remote to control the TV.

1. Press the number key 1 and  at the same time: The LED on your remote shows the first digit of the code by flashing. E.g., if the first number is 9, the LED flashes 9 times. No flashing means 0 (zero).
2. Press the number key 2 and  at the same time for the second digit of the code.
3. Press the number key 3 and  at the same time for the third digit of the code.
4. Press the number key 4 and  at the same time for the fourth digit of the code.

9.4 Reset the universal remote control

1. Press ,  and  at the same time for at least 3 seconds. The LED on your remote flashes 2 times.
2. All codes stored in the remote will be deleted. After restoring the factory settings on your remote, the LED flashes twice again.

9.5 Brand Code List

TV Brand	Brand code	TV code(s)
A.R. Systems	0583	
Accent	0583	0064
Acec	0039	
Acer	1366	1671, 2217, 1536, 1430
Acoustic Solutions	1694	
Adcom	0652	
Admiral	0120	0445, 0114, 0291
Advent	0903	
AEG	0633	2123, 1399, 2048, 1064, 1583, 2193, 1582, 1190, 2266
Agef	0114	
Aim	0064	0583
Aiwa	0728	0732, 1943, 1532
Akai	0388	0235, 0398, 0064, 0460, 0218, 1892, 1286, 1275, 1962, 2048, 2123, 1335, 0633, 0613, 1064, 0500, 0675, 0839, 0583, 0575, 0507, 0658, 0291, 0205, 0062, 0036, 0245, 0579, 0741, 0742
Akiba	0245	0064, 0583, 0321
Akura	1694	1672, 1797
Alkos	0062	
Allorgan	0321	
Allstar	0064	0583
Amoi	1556	2369
Amstrad	0036	0291, 0398, 0245, 0064, 0583, 0460, 1064, 0675, 2009, 1847
Anam National	0677	
Andersson	1190	1612, 1176
Anglo	0036	0291
Anitech	0036	0291, 0064, 0583
Ansonic	0397	0064, 0583, 0036, 0695, 0438, 0274, 1464, 0039
AOC	1615	0652, 2138
Apollo	0500	
Ardem	0513	0064, 0583
Arena	0064	
Aristona	0583	0064, 0039
Art Mito	1612	1847
ASA	0132	0373, 0097, 0114
Asberg	0064	0583
Asora	0036	
Astro	0667	
Atec	1633	
Atlantic	0064	0583

TV Brand	Brand code	TV code(s)
Atori	0036	
Audiosonic	0064	0583, 0136, 0741, 0742, 0397, 0291, 0245, 0513, 2010
Audioton	0513	0397, 0291
Autovox	0114	0571, 0376, 0274
Avol	1847	
Axxent	0036	
B&D	1244	
Baier	0903	1399, 2266
Bang & Olufsen	0592	0647, 0114, 1647
Barco	0579	
Basic Line	0064	0695, 0583, 0036, 0245, 1064
Bauer	1642	
Baur	0562	0222, 0539, 0064, 0583, 0581, 0218, 0388, 0571, 0376, 1532, 1037
Beaumarck	0205	
Beko	0741	0513, 0742, 0064, 0633, 1679, 2227, 1827, 0397, 0835
Bennett	0583	0064
BenQ	1589	1601
Beon	0064	0583, 0445
Best	0397	0448
Bestar	0064	0583, 0397
Black Diamond	1064	0583, 1190
Blackway	0245	
Blaupunkt	0581	0222, 0562, 0218, 0227, 0354, 0197
Blue Media	1633	
Blue Sky	0064	1064, 0741, 0514, 0695, 0742, 0835, 1390, 1341, 1943, 1270, 0652, 1679, 0651, 1936, 0583, 0245
Boman	1399	
Bondstec	0274	
Boots	0036	
Bosch	0354	
BPL	0064	0583
Brandt	0652	0136, 0223, 0314, 0362, 0498, 0370, 0587
Brandt Electronique	0314	0362
Brinkmann	0064	0583, 0695, 0546, 0445, 0513
Brother	0291	
Bruns	0114	0513
BSR	0321	0579, 0388
BTC	0245	

TV Brand	Brand code	TV code(s)
Bush	1064	1679, 0741, 1943, 0695, 1672, 0546, 1694, 0064, 0583, 1736, 1335, 0805, 0614, 1286, 2154, 0688, 1583, 0514, 1176, 1353
Canton	0245	
Capsonic	0291	
Carad	0637	0064, 0583, 0695, 1064
Carrefour	0097	0064, 0583
Cascade	0036	0064, 0583
Casio	0064	0583, 0376
CAT	1709	2182
Cathay	0064	0583
Centrum	1064	
Centurion	0064	0583
Century	0114	0274
CGE	0101	0445, 0274, 0579, 0397
Cimline	0036	0262, 0245
Cinex	1583	0675
City	0036	
Clarivox	0445	0064, 0583, 0097
Clatronic	1399	0633, 0245, 0064, 0583, 0741, 1704, 0036, 0398, 0675, 0397, 0274, 0291, 1190
Clayton	1064	
Concorde	0036	
Condor	0036	0397, 0438, 0445, 0064, 0274, 0291
Conia	1672	
Conrac	0835	
Conrad	0064	0583
Contec	0036	0038, 0291, 0064, 0583
Continental Edison	0136	0223, 0314, 0514
Cosmel	0036	0064, 0583
Crosley	0114	0274, 0101, 0579
Crown	0064	0513, 0633, 1064, 0742, 0514, 0235, 0445, 0397, 0741, 0036, 1679, 0695, 0448, 0680
CS Electronics	0245	0274
CTC	0274	
Cybertron	0245	
Cytronix	1325	
D.Boss	1501	0064
Daewoo	0661	0688, 0526, 1936, 1822, 0064, 0651, 2302, 0741, 0583, 0036, 0907, 1334, 0903, 0892, 1639, 0245, 1164, 2064
Dainichi	0245	

TV Brand	Brand code	TV code(s)
Dantax	0397	0513, 0741, 0633, 0742
Daytek	1403	
Daytron	0036	0064, 0583
de Graaf	0235	0575
Dell	1430	
Denver	1704	1216, 2077, 0614, 2123, 2048, 1661, 1872, 2272, 0064, 2015, 1736, 1847
Desmet	0064	0583, 0036, 0114
Diamant	0064	0583
DiBoss	0064	0583, 1501
Digatron	0064	0583
Digihome	1694	
Digiline	0064	0583, 0132, 0695
Digimate	0917	
Digital Device	1633	
Digitek	1736	
Digivision	0388	
DigiX	0907	
DiK	0064	0583
Dixi	0036	0064, 0583, 0274, 0114
DMTECH	2028	1991
Domland	0421	
Doric	0376	
Dream Vision	1731	1781
DTS	0036	
Dual	1064	2268, 0064, 1229, 0546, 0579, 1264, 1164, 0571, 0805, 0421, 1294, 0376, 0370, 1399, 1190, 0658, 1176, 2059, 0379
Dumont	0114	0097
Dunai	0571	
Durabrand	0064	1464, 0583, 2015, 1679
D-Vision	2009	0064, 0583
Dynatron	0064	0583, 0039
e:max	1399	1558
Edison-Minerva	0514	
Electrion	1612	
Elekta	0036	0064, 0583, 0291
ELG	0064	0583
Elin	0064	0583, 0132, 0575, 0388, 0376, 0036
Elite	0245	0064, 0583
Elta	0036	0291
Emco	0274	
Emerson	0114	0274, 1936, 0513, 0397, 0695, 0064, 0583, 0398, 0097, 0388, 0651
Emprex	1816	

TV Brand	Brand code	TV code(s)
Epson	0858	
Erres	0064	0583, 0039
ESC	0064	0583
Estèle	0579	
Etron	0064	0583, 0036
Eurofeel	0291	
EuroLine	0064	2077
Euroman	0291	0064, 0583, 0448, 0397
Europa	0064	0583
Europhon	0064	0583, 0274, 0579
Evesham	1694	
Exquisit	0064	0583, 0274
Fast	1928	
Fenner	0036	
Finlux	1694	0064, 0583, 1583, 2009, 1612, 1398, 0132, 1275, 0373, 0741, 0835, 0658, 0519, 0507, 0500, 0445, 0579, 0742, 0097, 0114, 0438
Firstline	0064	0583, 0695, 0741, 0651, 0036, 1390, 1190, 1398, 1639, 1335, 0376, 0262, 0235, 0388, 1064, 0835, 0321, 0274, 0579, 1936, 0438, 0571
Fisher	0235	0397, 0114, 0388, 0579, 0571, 0376
Force	1176	
Formenti	0064	0583, 0513, 0114, 0579
Formenti-Phoenix	0579	
Fortress	0120	0114
Fraba	0064	0583, 0397
Friac	0036	0064, 0583, 0448, 0397, 0526, 0682, 0637
Frontech	0274	0291, 0376, 0036
Fujitsu	0036	0379, 0064, 0583, 0388
Fujitsu General	0036	
Fujitsu Siemens	1693	1325, 0835, 2201, 1275, 1190, 1286
Funai	1844	1421, 1064, 1693, 1622, 0695, 0741, 0291, 0321
Future	0064	0583
Galaxi	0064	0583, 0388
Galaxis	0397	0064, 0445, 0583
Galeria	0036	
GBC	0579	0036, 0245
GE	0370	
GEC	0388	0376, 0064, 0583
Geloso	0274	0036, 0579
General Electric	0370	0314
General Technic	0036	

TV Brand	Brand code	TV code(s)
Genexxa	0245	0064, 0583, 0036
Gericom	1244	1633, 0892, 1325, 1233, 0907, 0835, 1748
Goldfunk	0695	
GoldStar	0064	0583, 0274, 0388, 0741, 0633, 0036, 0136, 0742, 0397
Gooding	0514	
Goodmans	1286	1275, 1822
Gorenje	0397	0448
GPM	0245	
Graetz	0388	0398, 1190
Gran Prix	0675	
Grundig	0222	1250, 0562, 0097, 1609, 0581, 0064, 0218, 0561, 2227, 1286, 1827, 0205, 0583, 1064, 1694, 0784, 1403, 0470, 1335, 2266, 2152, 0514, 2154, 1962, 1943, 0397, 0036, 0614, 0370
H&B	0835	2028
Haier	1642	
Halifax	0291	
Hanimex	0245	
Hanns.G	1640	
Hannspree	2054	2245, 1640, 1378, 2241
Hanseatic	0546	0064, 0661, 2028, 0526, 0688, 0652, 0421, 0741, 1991, 0835, 0388, 0513, 0583, 0036, 0571, 0321, 0114, 0376, 0397
Hantarex	0036	0064, 0583
Hantor	0064	0583
Harsper	0892	
Harwa	1223	1534, 1296
Hauppauge	0064	0583
HB	1399	
HCM	0036	0064, 0583, 0245, 0445, 0291
Hedzon	0583	0064
Hema	0036	
Highline	0291	0064, 0583
Hisense	1390	2125, 2064, 1341
Hit	0114	
Hitachi	1603	0508, 0605, 1799, 1064, 2234, 0526, 0771, 0064, 1072, 1511, 1221, 0252, 1508, 2241, 1881, 0388, 0661, 0746, 1190, 1612, 1176, 0824, 2154, 0507, 0904, 0519, 1164, 0575, 0376, 0500, 0911, 1694, 0579, 0223, 0370, 0136, 0132, 0205
Hitachi Fujian	0135	0252

TV Brand	Brand code	TV code(s)
HMV	0114	
Höher	0741	1583, 0892, 1190
Hugoson	1693	
Humax	1566	1322, 1848, 1562
Hyper	0036	0274
Hypersonic	0388	
Hypson	0064	0583, 0741, 0742, 0291, 1064, 0695, 0513
Hyundai	1308	1495, 1179, 0903, 1559, 1403, 0892, 1321, 1501, 1583, 1633, 0805, 1639
Iberia	0064	0583
ICE	0398	0245, 0291, 0064, 0036
Ices	0245	
Ict	0064	1164, 0583
IISonic	1403	
Iiyama	0904	0917, 2281, 1244
Ikasu	1704	
Imperial	0445	0579, 0274, 0101, 0223, 0397, 0064, 0376
Indiana	0064	0583
InFocus	1457	1233
Ingelen	0514	0637, 0741, 0388, 1464
Ingersoll	0036	
Inno Hit	0036	0064, 0583, 0245, 0274, 1190, 1612
Innovation	0546	0064, 0583
Innowert	0892	1325
Interactive	0064	0583, 0039, 0114, 0539, 0354, 0388, 0397, 0136, 0438
Interbuy	0036	0064, 0291, 0274, 0539, 0583
Interfunk	0064	0583, 0039, 0114, 0539, 0354, 0388, 0397, 0136, 0376, 0274, 0227
Internal	0064	0583, 0651, 0526, 1936
Intervision	0064	0398, 0546, 0513, 0397, 0421, 0514, 0245, 0291, 0274, 0036, 0583
Isukai	0245	0064, 0583
ITC	0579	
ITS	0064	0398, 0245, 0291, 0036, 0583
ITT	2152	0575, 0388, 0507, 0376, 0500, 0373, 0235, 0613, 0637
ITT Nokia	0388	0575, 0500, 0507, 0376, 0373, 0235, 0613, 0633, 0637, 0658
ITV	0291	
Jean	1540	
JEC	0062	
JGC	1704	1736
Jubilee	0583	

TV Brand	Brand code	TV code(s)
JVC	0680	1845, 1680, 0398, 2145, 0633, 0758, 0120, 0245, 0677, 0445
Kapsch	0388	
Karcher	0633	1583, 0448, 0805, 0064, 0637, 0741, 0397, 0583, 0291, 2152, 1335, 2009
Kathrein	0583	0064, 0907
Kawa	0398	
Kendo	1612	1064, 0637, 0438, 1176, 0397, 0064, 1464, 0513, 0675, 0274, 0546, 0262, 1164
Kennedy	0579	
Kiton	0583	0064, 0695
Kobra	1325	
Kolster	0064	0583, 0376, 0274, 0245
Konka	0064	0583, 0398, 0741, 0445, 0245, 2056
Kontakt	0514	
Korpel	0064	0583
Korting	0114	0448, 0397
Kotron	0291	
Koyoda	0036	
Kriesler	0039	
Kuba	0376	
Kuba Electronic	0376	
Kyoshu	0445	0291
L&S Electronic	0892	0741
LaSAT	0513	0397
Lava	1501	
Leader	0036	
Lemair	0438	
Lenco	0064	0036, 1822, 0583, 0614, 1064, 2010
Lentec	1558	
Lesla	0274	
Levis Austria	0064	0583
Lexsor	1223	1534
Leyco	0291	0064, 0583, 0321
LG	1450	2209, 0205, 1869, 0741, 1690, 1867, 0064, 1332, 1664, 1748, 0583, 1566, 0742, 0136, 0274, 0388, 0397, 0036
Liesenkötter	0064	0354, 0039, 0583
Lifetec	0064	0695, 1064, 1164, 0546, 2028, 0245, 0036, 0741, 0682, 1275, 1286, 0291
Loewe	0539	0660, 1911, 0817, 1863, 0114, 1817, 0682, 0397

TV Brand	Brand code	TV code(s)
Logik	0038	0398, 0907, 1244, 1064, 2056, 1672
Logix	0695	0546
Luma	0064	0438, 0583, 0036
Lumatron	0064	0583, 0388, 0291
Luxor	0507	0519, 0376, 0388, 0235, 0575, 0373, 0500, 1064, 0658
Madison	0064	0583
Magnavox	0064	0583
Magnum	0675	0741, 0064, 0742, 1316
Mandor	0291	
Manesth	0064	0583, 0262, 0291, 0062, 0321
Manhattan	0064	0583, 0695, 1064, 0805
Maqma	1816	1633, 1325, 1729, 1736
Marantz	0064	0583, 1559
Mark	0064	0583, 0036, 0741, 0742
Master's	0526	0064
Masuda	0398	
Matsui	1190	
Matsushita	0677	
Maxim	2009	1583
Medialine	1233	1991
Mediator	0064	0583, 0039
Medion	0835	1275, 0741, 1768, 0583, 1176, 1229, 1583, 0064, 0907, 1064, 1612, 1694, 0272, 1164, 1464, 0695, 1943, 2028, 0539, 1248, 1233
Megas	0637	
MEI	1064	0064, 0583
Melectronic	0373	0064, 0539, 0136, 0370, 0274, 0222, 0688, 0741, 1679, 0314, 0583, 0651, 0661, 0388, 0218, 0132, 0036, 0507, 0519, 0438, 0376
Memorex	0036	
Memphis	0036	
Mercury	0064	0036, 0583
Metz	0474	1560, 0773, 0394, 0415, 1190, 0695, 0114, 0064, 0222, 0562, 0561, 0581, 0218
Micromaxx	1399	0741, 0064, 0695, 0835, 1064, 2028
Microstar	0835	
Minato	0064	0583
Minerva	0514	1275, 0581, 0562, 0222, 0097, 0561, 0218, 0135
Minoka	0064	0583
Mirai	1693	2099, 1879
Mitsubishi	0135	0064, 0562, 0539, 1064, 0583, 0114, 0235

TV Brand	Brand code	TV code(s)
Mivar	0397	
Monaco	0036	
Morgan's	0064	0583
MTC	0397	0376, 0539, 0388
MTlogic	1335	
Multitec	0695	1064, 1583, 2009, 0064, 0583, 0513
Multitech	0376	0036, 0513, 0064, 0397, 0583, 0274, 0291, 0579
Musikland	0064	0245, 0274, 0583
Mx Onda	1672	1847
Myryad	0583	0064
NAD	0892	
Naiko	0064	0633, 0583
Nakimura	0064	0583
NEC	2171	0197, 0272, 1731, 0036, 0064, 0038, 0526, 0688, 0732, 0731, 0680
Neckermann	0064	0218, 0397, 1532, 1037, 0561, 0376, 0114, 0274, 0438, 0539, 0227, 0581, 0583, 0579, 0354, 0445
NEI	0064	0583, 0398, 1064
Neon	1759	
Neovia	1233	0892, 1991, 1398, 0903, 1403
Nesco	0274	
Netway	2136	
Neufunk	0064	0036, 0583, 0637, 0245, 0741
New Tech	0064	0036, 0583, 0370
Nikkai	1704	
Nikkei	0741	
Nobliko	0097	
Nokia	0500	0507, 0388, 0613, 0575, 0658, 0633, 0376, 0373, 0235, 0519, 0637, 0136
Nordmende	1440	0136, 0587, 2358, 2356, 0314, 1316, 0498, 2359, 0223, 0741, 0362, 0370, 1612, 2034, 2028, 1694, 1286, 0064, 0222
Normerel	0064	0583
Novak	0039	0064, 0583
Novatronic	0064	0132, 0583
Novita	1612	
Nurnberg	0388	
Oceanic	0388	0321, 0235, 0500, 0575, 0507, 2028
Odeon	0291	
Odys	2416	1822
Okano	0291	0036, 0397, 0064, 0583
Olidata	1403	

TV Brand	Brand code	TV code(s)
Omega	0291	
Onwa	0398	0245, 0460
Optoma	1781	1701
Orbit	0064	0583
Orion	2034	2032, 0470, 0741, 0262, 0682, 0064, 2135, 0321, 0583, 2027, 0907, 0382, 1943, 1223, 0571, 0291, 0038, 0036
Orline	0064	0245, 0583
Ormond	0695	1064, 0064, 0583
Osio	0064	0583
Oso	0245	
Osume	0245	0064, 0583
OTIC	1672	2010
Otto Versand	1532	1037, 0120, 0539, 0064, 0583, 0274, 0036, 0370, 0546, 0579, 0218, 0388, 0262, 0136, 0321, 0253, 0561, 0562, 0222, 0571, 0376, 0581
Pacific	0064	0583, 1164, 1264, 0741, 1064, 0470, 1399
Palladium	0397	0438, 0376, 0682, 0741, 0546, 0064, 0445, 0218, 1532, 1164, 0561, 0227, 0581, 0354, 0114, 0274, 0579, 0583, 1037, 2009
Panama	0036	0291, 0064, 0583, 0274
Panasonic	0677	1663, 1677, 0253, 1337, 1362, 0575, 0394, 0388, 0064, 0561
Papouw	0064	0583
Pathe Cinema	0376	0579, 0397
Pathe Marconi	0136	0223
Pausa	0036	
Perdio	0064	0583
Perfekt	0064	0583
Philco	0114	0101, 0445, 0274, 0579, 0397, 0064, 0583, 0546
Philips	0583	1533, 0064, 1771, 0666, 1894, 0632, 1610, 1522, 2042, 1273, 1482, 0039, 0799, 0581, 0036, 0388, 0227, 0114, 0370
Phocus	1335	0741, 1316, 1679, 1827
Phoenix	0064	0583, 0397, 0513, 0114, 0579
Phonola	0064	0583, 0039, 0114
Pioneer	1484	1287, 0706, 0193, 0787, 0064, 0388, 0136, 0513, 0539, 0397, 0370, 0314
Pionier	0397	0513
Plantron	0583	0291, 0036, 0064

TV Brand	Brand code	TV code(s)
Playsonic	0741	0064, 0742, 1827, 1679
Polaroid	1768	2152, 1672, 1550, 1747
Policom	0136	0223, 0388, 0097, 0101, 0114, 0562
Poppy	0036	
Portland	0651	1936
Powerpoint	0514	0064, 0583, 1797
Prandoni-Prince	0274	0388
Prima	0036	0291, 1296, 1534, 1223
Prinz	0571	0376, 0388
Profex	0036	0388
Profi	0036	
Profilo	1583	
Profitronic	0064	0583
Proline	0064	0583, 0652, 0661, 0438, 0039, 1403, 1540, 1064
Prosonic	0695	0741, 1759, 2117, 2272, 0064, 0583, 0397, 0398
Protech	0064	0583, 0036, 0274, 0376, 0291, 0445, 0695, 0579, 0513, 1064
Proview	1672	
Provision	1064	1558, 0064, 0583, 0741, 1399
Pye	0064	0583, 0039, 0114, 0581, 0376
Pymi	0036	
QONIX	1661	
Quadral	0245	
Quasar	0274	0892, 0036
Quelle	0064	1532, 1037, 0038, 0136, 0539, 0373, 0448, 0579, 0036, 0583, 0222, 0227, 0291, 1064, 0321, 0274, 0101, 0354, 0097, 0132, 0695, 0562, 0571, 0376, 0581, 0218, 0388
radiola	0064	0583, 0039
radiomarelli	0114	0274, 0064, 0583
radioShack	0064	0583
radiotone	0695	0675, 0064, 0036, 1064, 0397, 0445, 0291
Rank	0097	
RBM	0097	
Recor	0064	0583
Rectiligne	0064	0583
Red Star	1583	
Rediffusion	0388	0575, 0373
Redstar	0064	0583
REEL Multimedia	1451	
Reflex	0064	0583, 1064, 0695
Relisys	1768	1672, 0904, 1233, 1325, 1403, 1612, 1639, 0892, 0903

TV Brand	Brand code	TV code(s)
Revox	0064	0835, 0583, 0397
Rex	0438	0274, 0291
RFT	0291	0114, 0397, 0064, 0583, 0513
Ricoh	0064	0583
Roadstar	1064	0742, 0741, 0036, 0064, 1216, 1582, 1353, 0583, 0445, 0695, 1464, 0245, 0291, 1943
Robotron	0114	
Rowa	0583	0291, 0036, 0614, 0064
Royal Lux	0448	0397, 0362
Rukopir	0583	0064
Saba	0652	0362, 0136, 0587, 0370, 0114, 0223, 0498, 0314, 1064, 0388, 0575, 0525, 1615, 0741, 0583
Sagem	0637	0857, 1340, 0645
SaiVOD	0064	0583, 0695, 1064
Salora	0376	0388, 0575, 0235, 0579, 0507, 2152, 1264, 0658, 1583, 0805, 1398, 1229
Salsa	0362	
Samsung	2078	0839, 1485, 0645, 1339, 0614, 2164, 1276, 1657, 1705, 2121, 0671, 0583, 1262, 0064, 0036, 0793, 1659, 0397, 0546, 0291
Sansui	0064	0583, 0398, 1962
Santon	0036	
Sanyo	0235	1235, 1674, 1612, 0036, 1694, 0571, 1676, 1064, 1675, 0135, 0197, 0731, 0397, 0038
Save	0064	0583
SBR	0064	0583, 0039
Schaub Lorenz	0741	2127, 1399, 0513, 0575, 0633, 1398, 0388, 1221, 0376, 2152, 1694, 1390
Schneider	0583	1164, 0064, 1064, 2155, 1644, 0695, 0546, 0379, 0039, 0571, 1501, 0376, 1395, 0274, 0741, 1399, 2009, 0421, 1264, 0398, 0388, 0245, 0370, 1943, 0097, 0675
Scott	1216	2010
Seaway	0661	
SEG	1064	0695, 1190, 0064, 1176, 1936, 1464, 0651, 0579, 0583, 1928, 1612, 1694, 0036, 2088, 0514, 0661, 0291, 0245, 0376, 0274
SEI	0114	1532, 1037, 0579, 0571, 0376, 0321, 0064, 0583

TV Brand	Brand code	TV code(s)
Sei-Sinudyne	0321	1532, 1037, 0579, 0571, 0064, 0583, 0114
Seleco	0438	0398, 0291, 0373
Sencora	0036	
Sentra	0062	0245, 0036, 0376
Sharp	1686	0120, 1220, 1420, 1614, 2241, 1846, 1613, 0321, 0227, 0680
Shintoshi	0064	0583
Shivaki	0064	0583, 0470, 0205
Siarem	0579	0114
Siemens	0222	0581, 0218, 0562, 0227, 0354, 0064, 0561, 0583, 0388
Siera	0064	0583, 0039, 0614
Siesta	0397	
Silva	0388	0675, 0064, 0583
Silva Schneider	1583	2193, 0675, 2152
Silver	0388	0742
Simz	1847	
Singer	0036	0114, 0064, 0583, 0274, 0362
Sinudyne	1399	0114, 0262, 0321, 0579, 0388, 0633, 0571, 0376, 1532, 1037, 0064, 0583
Sky	1540	1640, 1633, 1772, 0688, 0892, 0907, 0205, 1531, 1642, 1403
Skymaster	0132	
Sliding	0892	0907, 1399, 1395
Smaragd	0514	
Soemtron	0892	1325
Sogo	1403	
Solavox	0388	0575, 0064, 0583
Sonawa	0245	
Soniko	0064	0583
Sonitron	0235	0397
Sonoko	0064	0583, 0036, 0291
Sontec	0064	0583, 0397, 0321, 0036
Sony	1852	1532, 1678, 1778, 1037, 0038, 1712, 0861, 0064, 0120, 0197, 0101
Sound & Vision	0245	0064, 0583
Soundwave	0064	0583, 0445, 0742
Standard	0064	0583, 1064, 0245, 0036
Starion	1064	
Starlite	0036	0579, 0064, 0583, 0291
Starmedia	2136	
Stenway	0245	
Stern	0291	0438
Strato	0064	0583, 0291, 0036
Strong	0064	0583, 1190, 1176, 1064

TV Brand	Brand code	TV code(s)
Sungoo	2064	
Sunic Line	0064	0583
Sunstar	0398	0064, 0583, 0036, 0291
Sunstech	2028	1991
Sunwood	0036	0064, 0583
SuperTech	0036	0064, 0583, 0245
Supra	0036	
Susumu	0362	0245, 0314
Sutron	0036	
Swedx	1633	
Swissline	0274	
Swisstec	1531	
Sysline	0064	0583
T+A	0474	
Tandberg	0394	0438, 0136, 0223, 0388
Tandy	0245	0274, 0120
Targa	0645	2272, 1398, 1294
Tatung	1747	1275, 0064, 0583, 1399, 1286, 1583, 1398, 0038
TCM	2028	1335, 0741, 1316, 0835
TEC	0036	0274, 0498, 0362, 0579, 0064, 0583, 0388
Tech Line	0064	0583, 0695, 1464, 1190
Tech Lux	1216	
Technica	2009	
TechniSat	1294	0667, 0064, 2182, 0583, 0682
Technisson	0741	1316, 1679
Technotrend	1729	2182, 1558
Techvision	1736	1558
Techwood	1190	1064, 1694
Teco	1340	2136, 1550
Tedalex	0633	0064, 0036, 0235, 0614, 0583
Teiron	0036	
Telefunken	0289	0652, 0498, 0128, 0362, 0136, 0314, 0525, 0370, 0587, 0101, 0064, 0513, 0741, 1583, 0373, 0223
Telefusion	0064	0583
Telemeister	0064	0583
Telesonic	0064	0583
Telestar	2345	0064, 2117, 0583
Teletech	0064	0695, 1064, 0036, 0274
Teleton	0376	
Televideon	0579	
Teleview	0064	0583
Tensai	0245	0064, 0583, 0321, 0036, 0132, 0398, 0274, 0742, 1064
Tenson	0036	
Tesla	0064	

TV Brand	Brand code	TV code(s)
Tevion	1275	1164, 0741, 0583, 1583, 1064, 2050, 0695, 0835, 1768, 0675, 2268, 1316, 1827, 2117, 1612, 0892, 1286, 0064
Texet	0036	0245
Thomson	0652	0587, 0314, 0370, 0362, 0498, 0136, 1615, 0223, 2155, 0064, 0376, 0579
Thorn	0135	0136, 0252, 0370, 0097, 0128, 0388, 1532, 1037, 0562, 0038, 0039
Thorn-Ferguson	0362	0062
Tokyo	0062	
Topline	0695	1064
Toshiba	1535	0535, 0062, 0745, 1609, 0580, 1764, 1316, 0222, 1457, 1064, 0268, 1583, 1962, 0645, 0677, 1972, 1731, 0097, 1943, 0036, 0136
Towada	0376	0579
Toyoda	0036	
Trakton	0291	
Triad	0583	0245, 0036, 0064
Trio	1672	
Tristar	0291	0245
TVTEXT 95	0583	
Uher	0064	0583, 0445, 0513, 0397, 0507
Ultravox	0064	0114, 0274, 0579, 0583
Unic Line	0064	0583, 0500, 0376
United	1679	1847, 1797, 0583, 1943, 1064, 0614, 2009, 2227, 0741, 0064, 0742
Universum	1064	0064, 0373, 1190, 0695, 1464, 0500, 0438, 0132, 0507, 1264, 0036, 0388, 0291, 0354, 0562, 0097, 0519, 1928, 0579, 0038, 0539, 1176, 0658, 0397, 0274, 0645, 0571, 0581, 0445, 0448, 0197, 0136, 0101, 0227, 2201, 0376, 0222, 1532, 0321, 1037
Univox	0064	0583, 0114
V7 Videoseven	1244	1693, 2281, 0907, 1403, 1294
Vestel	1064	1190, 1612, 1694, 0064, 0695, 0579, 0583
Vexa	0036	0064, 0583
Videologic	0245	
Videosat	0274	
VideoSystem	0064	0583
Viewpia	0903	
ViewSonic	1569	1615, 1540, 2136, 2138

TV Brand	Brand code	TV code(s)
Vision	0064	0583
Vistar	0388	
Vortec	0064	0583
Voxson	0114	0064, 0583, 0445, 0205
Waltham	1064	0470, 0445, 0314, 0064, 0583, 0695, 0136
Watson	0064	1064, 0546, 0036, 0695, 1275, 1403, 1464, 0354, 0421, 0245
Watt radio	0571	0376, 0579, 0513
Wega	0064	0583, 0114
Wegavox	0036	0064, 0583
Welltech	1679	
Weltblick	0064	0583
Weltstar	1064	
Weston	0064	0583
White Westinghouse	0064	0583, 0651, 1936
Wilson	0583	
Windy Sam	0583	
World-of-Vision	0907	1759, 2028, 0917, 0892, 1316, 1325, 0904, 1633, 1244
Xomax	1797	
Xoro	1816	2094, 1534, 2173, 1223, 1244, 1270, 2172
Xrypton	0064	0583
Yakumo	1640	2324
Yamaha	0677	0824, 1553, 1603
Yokan	0064	0583
Yoko	0064	0583, 0245, 0291, 0036, 0448, 0397, 0274
Yorx	0245	

10 Troubleshooting

Problem	Solution
The remote control does not work.	<ul style="list-style-type: none"> • Press  to switch to Receiver mode. • Point the remote towards the Receiver. • Check the batteries and check that the batteries are inserted correctly.
The Receiver displays a black screen or an error message.	<ul style="list-style-type: none"> • Search for channels (see chapter 7.1.4, Delete additional channels).
The picture is frozen and / or blurred.	<ul style="list-style-type: none"> • Check all connections, the antenna cable, and search for channels again (see chapter 7.1.6, Start a channel search).
The Receiver cannot find any channels.	<ul style="list-style-type: none"> • Check the cable connection. • Check the antenna signal (see chapter 2, Connections to the network and connecting additional devices). • Search for channels (see chapter 7.1.6, Start a channel search). • Check with your cable company for more information about your home connection.
The TV does not recognize the Receiver if he leaves the standby mode.	<ul style="list-style-type: none"> • "Check if your TV is connected to the TV SCART connector (see chapter 2, Connections to the network and connecting additional devices). • "Select the SCART input on the TV, if necessary.
At some channels, no audio in Home Cinema mode is displayed.	<ul style="list-style-type: none"> • Check whether the Receiver is connected to a Home Cinema amplifier via optical SPDIF connector (see chapter 2, Connections to the network and connecting additional devices).
Black and white video at VCR output (during VCR / DVD recording).	<ul style="list-style-type: none"> • "Check that the mode selected for the VCR SCART output type is compatible with your VCR (see chapter 7.2.3, Picture).
All other problems.	<ul style="list-style-type: none"> • Reset device to factory default (see chapter 7.1.7, Reset to factory default).

11 Support

This product has been designed with great care to ensure the best possible quality. In the unlikely case you have difficulties with the product and need advice or support, you can rely on the best possible help.

For technical problems with the product, you may contact Kabel Deutschland directly:

0800/ 52 666 25
Mon - Sun 0:00 - 24:00
(free of charge from Germany)

12 Explanation of terms

Term	Definition
BER	Bit Error Rate The bit error rate defines the transmission quality from the number of incorrectly transmitted bits.
EPG	Electronic Programme Guide Digital program guide, where you can view the programs, channels and search for content.
FSK	Voluntary self-regulation of the film industry (Freiwillige Selbstkontrolle der Filmwirtschaft) German organization that maintains a movie rating system, which draws on the parental control feature. The Receiver's replays content with classification G-16 or higher only if the parental protection PIN is entered.
Non entitled channels	Channels that are saved in the channel list but can not be displayed because you have no entitlement.
OSD	On Screen Display Menus and messages that are displayed on the screen.
Service Info	Text message that is sent from the channel or cable operator. See chapter 7.6.2, Service messages .
Smartcard	Electronic smartcard to decrypt encrypted digital TV or radio broadcasts. Slide the smartcard with the chip facing downwards into the reader of the Receiver to view programs for which you are unlocked.
Start Channel	Channel on which the Receiver systematically tunes to wherever the Receiver is switched on or woke up after standby.
Timeshift Mode	Time-shift recording mode, which allows to stop and rewind current broadcasts and watch it again.
Video Subchannel	Channels or programs that transfer more than one video channel at a time and offer you the option of choosing from different video channels.
VOD	Video on Demand (Select Video) Interactive services for direct retrieval of a wide range of programs. To use this service, the Receiver must be connected to the internet, Select Video must be available in your region and you must be unlocked for this service.

13 Specifications

TRANSMISSION STANDARDS

DVB-C, IP, MPEG-2, MPEG-4

CABLE FRONT END

CABLE RF INPUT

Input frequency range: 47-862 MHz (6, 7, & 8 MHz BW)

RF input level: -15 to +15 dBmV

RF impedance: 75 Ohms

Tuning step: 62.5 kHz

RF OUTPUT

Loop through output frequency range: 47-862 MHz

CABLE DEMODULATOR

DVB-C Demodulator

Waveform QAM 16,32,64,128,256

Symbol rate: 1 to 6.96 MS/s Mbauds

Roll-off factor: 0.15

Decoder RS (204, 188, 8)

De interleaver: convolution type, Depth I = 12

PROCESSOR AND MEMORIES

Processor: ST 7105 - 800 Mips

RAM memory: 256 Mbytes

Flash memory: 64 Mbytes

EEPROM emulated into Flash

ETHERNET 10/100BT

Fully integrated IEEE 802.3/802.3u 10/100 base T-Physical layer

Auto-negotiation 10/100

Full/Half Duplex

Adaptive equaliser

Baseline wander correction

VIDEO DECODING

MPEG2

Standard MPEG-2 MP@HL for 50 Hz

Input rates (max): 15 Mbit/s at ship input

MPEG-4 Part 10 / H.264

- MPEG4 AVC HP@L4 (HD) for 50 Hz
Input rates (max): 20 Mbit/s for HP@L4

- MPEG4 AVC HP@L3 (SD) for 50 Hz
Input rates (max): 10 Mbit/s for HP@L3

CABAC and CAVLC decoding

Supports all intra/inter prediction modes and block sizes I, P and B picture types

Fidelity range extensions (8x8 Transforms, 8x8 Spatial Prediction Mode, Dynamic Quantization Matrix)

AUDIO DECODING

MPEG-1 layer I & II (Musicam)

MPEG-2 layer II

Mode: Mono, stereo, joint stereo

Sampling rates 32, 44.1 or 48 KHz

HE-AAC

Dolby Digital

Dolby Pulse

Mode: pass through and down mixing

Mode: pass through, transcoding in Dolby Digital, and down mixing

OUTPUT RESOLUTION FORMAT

For HD broadcast

1920x1080 @ 50 Hz progressive, or 1920x1080 @ 50 Hz interlaced and progressive (motion adaptative spatial and temporal de-interlacing)

(HD>SD) by set up menu

For SD broadcast

720x576 - Aspect ratio: 4:3 and 16:9

Conversion: Pan and Scan, Letter box

Scaling: SD > HD

HD or SD

Resizing: down $\frac{1}{4}$ and up no limit

SD INPUT/OUTPUT

TV SCART

RGB out, CVBS, Y/C, Audio R/L

AUX SCART

CVBS, Y/C, RGB in, Audio R/L

Protection Macrovision 7.0.1

CGMS-A

HDMI OUTPUT

HDMI 1.3 with HDCP 1.1 including CEC

Rely on the (E)EDID HDMI information returned by the display device

AUDIO OUTPUT

Optical S/PDIF

Two channels PCM in case of MPEG1-layer II,

Originally received bit stream in case of Dolby Digital

HiFi audio output

Mono stereo in case of MPEG1 layer II, Two channels down mixed in case of Dolby Digital

CONDITIONAL ACCESS

1 x Smart card reader, ISO/IEC 7816

DATA PORT

2 x USB 2.0 Host (High Speed)

1 x RJ45 (Ethernet 10/100 base T)

FRONT PANEL

1 x Smart Card reader

1 x IR sensor: 36 kHz

4 x Buttons (Standby, P+, P-, TV/radio with LEDs)

1x USB 2.0 Host (High Speed)

REAR PANEL

1 x IEC169-2 (female: RF In)

1 x IEC169-2 (male: RF Out)

2 x SCART (TV, AUX)

1 x HDMI

2 x RCA Stereo L/R

1 x Optical S/PDIF

1 x RJ45 (Ethernet 10/100 base T)

1x USB 2.0 Host (High Speed)

1 x Power On/Off switch

POWER SUPPLY

Mains supply voltage: 220-240 V
~50 Hz

Max. Power consumption: 25 W

Standby mode: < 1 W

PHYSICAL SPECIFICATIONS

Receiver:

- Size (wxdxh): 310x175x41 mm

- Weight: ~0.780 Kg

- Operating temperature: 0°C to +40°C

- Storage temperature: -25°C to +65°C

ACCESSORIES

1 x Power cord for internal AC/DC
(1.8 m)

1 x Remote control

2 x Alkaline 1.5 V batteries (AAA type)

1 x HDMI cable (2 m)

1 x RF cable (2 m)

1 x Quick Installation guide

SAGEMCOM

Sagemcom Broadband SAS

Headquarters: 250, route de l'Empereur
92848 Rueil-Malmaison Cedex - FRANCE

Tel : +33 (0)1 57 61 10 00 - Fax : +33 (0)1 57 61 10 01

www.sagemcom.com